

ROSETTA®

TECHNICAL GUIDE





TABLE OF CONTENTS

5 WALLS

6	GENERAL INFORMATION
11	OUTCROPPING
20	GRAND LEDGE
25	BELVEDERE
30	KODAH
33	HEARTWOOD
35	CLAREMONT
38	DIMENSIONAL

41 SLABS & PAVERS

42	GENERAL INFORMATION
44	GRAND FLAGSTONE
48	DIMENSIONAL FLAGSTONE
51	LINEAR FLAGSTONE
53	24 X 24 FLAGSTONE
55	MIROS
57	NEW MISSION
60	OLD MISSION
63	AMARO
65	BORDO
66	SUPERIOR STEPPERS

68 STEPS

69	GENERAL INFORMATION
70	IRREGULAR
72	DIMENSIONAL

73 FIRE FEATURES

74	GENERAL INFORMATION
75	BELVEDERE FIRE PIT
77	DIMENSIONAL FIRE PIT
78	KODAH FIRE PIT
79	DIMENSIONAL WEDGE FIRE PIT

81 COPING & CAPS

82	DIMENSIONAL COPING
83	BELVEDERE COPING
84	BULLNOSE COPING
85	COLUMN CAPS

87 MAINTENANCE

88 ADDITIONAL INFORMATION

Notes:

* Written specifications for products are available on our website.

** Colors & product availability vary by region.



WALLS

GENERAL INFORMATION

OUTCROPPING

GRAND LEDGE

BELVEDERE

KODAH

HEARTWOOD

CLAREMONT

DIMENSIONAL



PRE-CONSTRUCTION CHECKLIST

Before you start construction, take the time to complete the necessary planning and preparation. This process will keep your project running efficiently and will aid in completing a quality installation.

Make sure to address the following:

SAFETY

Your safety program should address items such as personal protective equipment, maintaining safe slopes and excavations, fall protection, rigging and lifting, as well as any other relevant safety precautions.

ENGINEERING AND PERMITS

Obtain the necessary engineering design and permits for your project. The soils for foundation and wall backfill should be properly evaluated by a trained professional. Unsuitable soils should be removed and replaced as recommended.

Note: This installation guide is intended to supplement a detailed, site-specific wall design prepared by a Professional Engineer. The construction documents for your project supersedes any recommendations presented here.

REVIEW THE PROJECT PLANS

Take the time to review and understand the project plans and specifications. Make sure you understand the detailed design for the project before starting construction. A pre-construction meeting with the wall designer, construction inspector, wall contractor, and owner or representative is recommended. Don't be afraid to ask questions.

CONSTRUCTION PLANNING

Develop a plan to coordinate construction activities (material delivery/storage, equipment access, etc.) on your site. Make sure your plan specifically addresses how to control surface water during construction.

UTILITY LOCATION

Make sure to have underground utilities located and marked on the ground before starting any construction.

Call 8-1-1 or go online to call811.com to schedule utility marking for your project site.

MATERIAL STAGING

Store retaining wall blocks in a location close to the proposed wall. Blocks should be kept clean and mud free. Blocks should also be stored in a location which will minimize the amount of handling on the project site.

Store geogrid in a clean, dry location close to the proposed wall site. Keep the geogrid covered or in the shade until installation to avoid exposure to direct sunlight.

EQUIPMENT

Make sure you have the proper equipment to handle retaining wall blocks and pallets on the construction site (Note: A specially designed Lifting Device is required for the installation of Outcropping blocks).

Hand operated equipment used in wall construction should include shovels, rake, 2 ft (600 mm) level, 4 ft (1.2 m) level, broom, hammer, chisel, tape measure, string, spray paint, laser level, pry bar, concrete saw and a walk behind vibratory plate compactor capable of delivering a minimum of 2000 lb (9 kN) centrifugal force.

Personal protective equipment should include appropriate clothing, steel toe boots, eye protection, respiratory protection, hard hat, gloves, hearing protection, fall protection, rigging, and other items as necessary to insure a safe working environment.

Note: On small or difficult to access sites, it is helpful to have two lifting devices. One for moving material from pallets to the site and another for setting blocks. This will allow for the material staging area to be located away from the construction space while providing safe and efficient access to the material in less than desirable site conditions.

INSTALLATION GUIDE

**BASIC RETAINING WALL
INSTALLATION NOTES FOR:**

- Outcropping
- Grand Ledge
- Belvedere
- Kodah
- Heartwood
- Dimensional
- Claremont

Refer to product pages for specific information and details pertaining to individual products.

BASE PREPARATION

Proper base preparation is a critical element in the construction of your retaining wall. Not only is it important to provide a stable foundation for the wall, but a properly prepared base will greatly increase the speed and efficiency of your wall installation.

Proper base preparation starts with the subgrade soils (soils below the leveling pad). A typical wall requires excavation of at least 12 in (300 mm). This will provide 6 in (150 mm) for the leveling pad and 6 in (150 mm) of minimum bury of the blocks. **Note: excavation and bury depth will vary by product type and design. Please see project plans or product specific information for further information.** Subgrade soils should be firm and capable of supporting the loads from the wall. At a minimum, all topsoil, organic, and other unsuitable soils should be removed from below the wall. The minimum width of the leveling pad should be 18 in (465 mm) wider than the width of the block. This will provide 6 in (150 mm) in front of and 12 in (300 mm) behind the bottom block. **Note: for Outcropping and Grand Ledge Installation, you will need a wider leveling pad to ensure there is enough space for the depth of the blocks. The back cut behind the wall should taper and provide at least 18 in (465 mm) of space to ensure that the lifting device has enough clearance to be removed efficiently. When the back cut is too close to the back side of the wall, the device can get wedged and be hard to remove.**

Once excavated, the subgrade soil should be compacted to a minimum of 95% maximum density as determined by a standard proctor test (ASTM D698). At this point the soil should be firm and free of topsoil, debris, roots, etc. Consult a soils engineer if in doubt. Any unsuitable material shall be excavated and replaced with compacted granular soils as directed by the engineer.

LEVELING PAD

Base preparation continues with proper leveling pad construction. An open-graded (free-draining) crushed stone leveling pad is typically used for retaining walls. Walls can also be designed with a dense-graded

FOR THE MOST NATURAL APPEARANCE, MIX AND INSTALL PRODUCTS FROM MULTIPLE PALLETS SIMULTANEOUSLY. THIS WILL CREATE A MORE BLENDED, NATURAL LOOK.

crushed stone or concrete leveling pad. The choice of which type of leveling pad to use is made by the wall designer and depends on several factors including the bearing capacity of the native soil, location of the drain outlet, conditions at the base of the wall, and any other special considerations for the wall.

The leveling pad material should be placed and compacted to provide a uniform, level foundation on which to construct the retaining wall. Proper elevation can be established with a laser level or transit. Check for level both parallel and perpendicular to the wall.

Place and compact leveling pad material as specified in the wall design. If crushed stone is used, place the stone in uniform loose lifts a maximum of 6 in (150 mm) thick. Lift sizes are relative to the size of the compactor being used. Compact the stone with a minimum of three passes with a 24 in (610 mm) wide, walk-behind, vibrating plate compactor

Note: Do NOT place a thin layer of sand between the leveling pad and bottom block. This layer will reduce the sliding resistance between the leveling pad and bottom block, as well as reduce the drainage capacity of the foundation stone.

DRAIN

A drain is installed in the lowest part of the open graded (free-draining) stone behind the retaining wall. If an open graded crushed stone leveling pad is used, the drain is installed on the bottom of the crushed stone leveling pad. If a dense graded crushed stone leveling pad is used, the drain is installed immediately on top of the dense graded stone.

Typically, a 4 in (100 mm) diameter perforated or slotted pipe (PVC or corrugated HDPE) is used. Daylight the drain pipe at the ends and/or through the face of the wall every 50 ft (15 m) to allow for drainage. The pipe can also outlet into a nearby drainage ditch or catch basin. Because water can flow both ways through the drain pipe, connection to a catch basin or active storm sewer should only be made under the direction of a Professional Engineer.

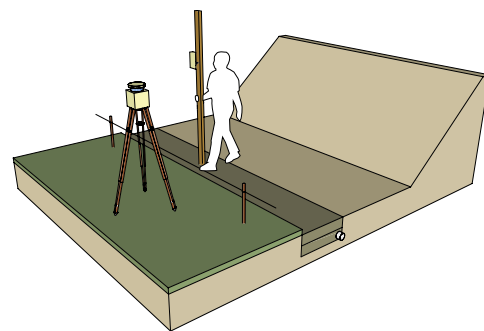
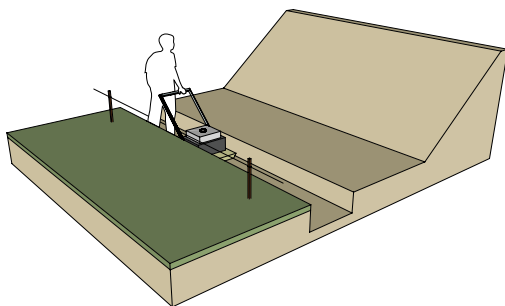

SETTING THE BOTTOM COURSE OF BLOCKS

Proper placement of the bottom course of wall stones is critical in determining the overall appearance and integrity of the finished project. Take extra time on this step and the rest of the project will go smoothly. At this point you need to determine the best point of origin for the wall. If you have a fixed point, such as a building corner or a 90° corner, you will want to start the wall from that point and work your way out. This will minimize cutting of blocks. If there are no fixed points, start the wall at the lowest design elevation, as it is easier to step the base up than it is to step the base down.

Properly mark the location of the retaining wall. A string line or offset stakes are typically used to establish horizontal and vertical alignment. Review the Outcropping section for specific instructions on block alignment.

Where applicable, remove the bottom lip from the back edge of the blocks (applicable for Outcropping and Grand Ledge) with a hammer and chisel (bottom course of blocks only) so the blocks will lie flat on the leveling pad.

Place a complete row of blocks on the prepared leveling pad. Blocks should be placed tight together.

Check all blocks for level from front to back and side to side as they are placed. Place and compact backfill in front of the bottom row of blocks to help hold them in place. Compaction should be to 95% maximum density as determined by a standard proctor test (ASTM D698).

Place open-graded crushed stone in the wedge-shaped gap between the blocks and at least 12 in (300 mm) behind the wall. A stone meeting the gradation requirements of ASTM No. 57 with no material passing the No. 200 sieve is preferred. Place the stone in uniform loose lifts a maximum of 8 in (200 mm) thick. Fully consolidate the stone. Carefully hand tamp the stone within 12 in (300 mm) of the blocks.

Place non-woven geotextile fabric between the drainstone and the remaining backfill material if specified. This prevents backfill material from migrating into, and clogging, the open-graded drainstone.

Backfill behind the drainstone with material as specified in the project design. Place the material in loose lifts as specified, but not to exceed 8 in (200 mm) maximum. Granular backfill shall be compacted to a minimum of 95% maximum density as determined by a standard proctor test (ASTM D698). Do not use any organic, topsoil, frozen, soft, wet, or loose soils when backfilling the wall.

Re-check all units for level and alignment and sweep the top of each course of blocks clean before starting construction of the next course.

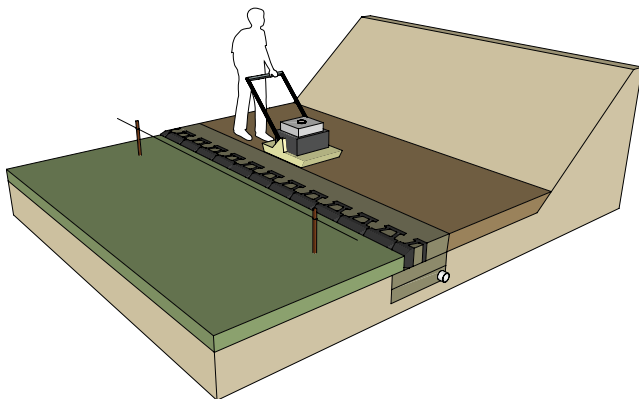

SETTING THE UPPER COURSES OF BLOCKS

Placing the next course of blocks is similar to placing the first course. Blocks should be placed to establish a running bond pattern (Dimensional Collections) or to follow an irregular pattern (Outcropping, Belvedere, and Claremont Collections).

Blocks should be installed with their sides pushed tight. Push blocks from Outcropping and Grand Ledge collections forward until the lip on the back of the block comes in full contact with the blocks below. Make sure that no stones get caught or wedged between the lip and the back of the blocks below. Walls without the lip on the bottom (Belvedere, Dimensional, Kodah Freestanding, and Claremont Collections) should not be stacked exactly vertical. Instead, they should be setback as specified by each product line.

(Outcropping: Place a layer of non-woven geotextile fabric directly behind the blocks. This will keep materials from eroding through the small voids between the blocks.)

Place Geogrid reinforcing behind the wall as specified in the project documents. See geogrid installation information in the next section for further details.

Place and compact open-graded crushed stone between the blocks, and at least 12 in (300 mm) behind the wall following the procedure used for the bottom course of blocks.

Place non-woven geotextile fabric between the drainstone and the remaining backfill material if specified.

Place and compact backfill behind the drainstone following the procedure used for the bottom course of blocks.

Re-check all units for level and alignment and sweep the top of each course of blocks clean before starting construction of the next course.

Repeat these steps with each course of blocks to the top of the wall.

GEOGRID INSTALLATION

Stability of reinforced soil walls rely on the interaction between geogrid reinforcement, soil in the reinforced zone, and the retaining wall blocks. It is very important that reinforced soil walls be constructed per the detailed design prepared by a Professional Engineer. Make sure you are using the proper type and strength of geogrid listed in the design. The geogrid layers need to be placed at the proper elevations and to the proper distances into the reinforced soil zone detailed in the design. It is also critical to use the appropriate backfill soil material in the reinforced soil zone.

Construct the wall up to the elevation of the geogrid layer shown in the design.

Place geogrid layers as shown in the project details extending into the reinforced soil zone to the design length.

Geogrid must be installed with the strong direction (roll direction) into the reinforced soil zone and not parallel to the wall. Geogrid must be placed in a continuous sheet throughout its length from the connection at the blocks to the back of the reinforced zone. Do not splice or overlap the geogrid.

For all retaining wall products except the Outcropping Collection, use the next layer of blocks to secure the front end of the geogrid (creating a friction connection). Make sure the geogrid is as close as possible to the front face of the wall without being visible. Pull the geogrid taut to eliminate any folds and pretension the geogrid. Pin or secure the back edge of the geogrid before placing the reinforced fill. Review the Outcropping section for specific instructions on geogrid and parawab strap installation.

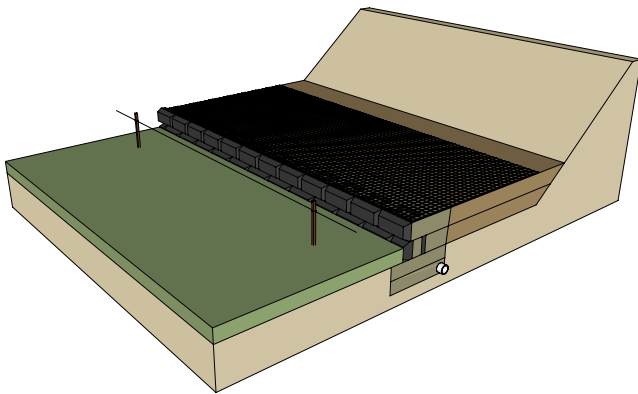

FINISHING THE TOP OF THE WALL

Completing a few simple tasks near the end of the project will ensure that the wall will function properly and look good for years to come.

Grade the top of the wall in such a way that surface water runs off away from the wall. Never leave the top of a wall graded where surface water will pond behind the wall, or saturate the backfill soils.

Place a layer of non-woven geotextile fabric over the top of the drainstone at the back of the wall. This will keep topsoil from migrating into the drainstone and causing problems.

If required, place the coping layer on the top of the wall. The coping blocks should be placed towards the front edge of the wall blocks and should sit securely on top without tipping forward under their own weight. The coping layer should be carefully adhered with a concrete adhesive specifically formulated for segmental concrete block wall construction.

Note: With Outcropping and Grand Ledge, freestanding units can be used as capstones for applications where the top of wall is expected to be above the finished grade behind the wall. If the FS units are not available in your local market, Rosetta step units are also a great option.

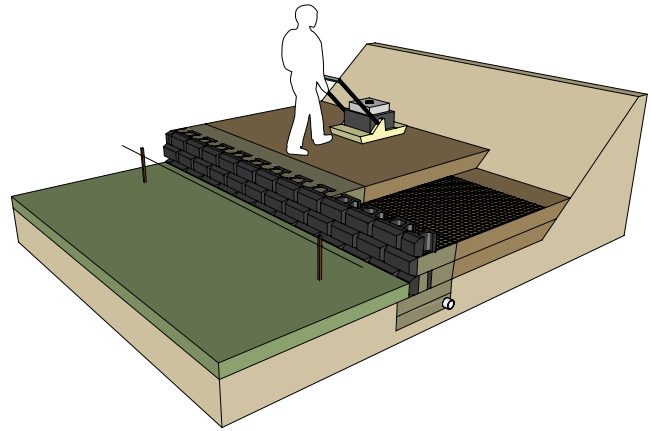

MORE INFORMATION

Refer to product-specific **Notes and Typical Construction Details** for specific applications and construction practices such as chimney drain construction, fence installation, corner construction, drain placement, curve construction, and other details.

Typical allowable construction tolerance at the wall face is 1 in (25 mm) in 10 ft (3 m) (1:120) in the vertical and horizontal directions, and a rotation tolerance of 2° from wall batter.

Once you commence working, continue without interruption or delays. This will help expedite construction and minimize the time the excavation is open.

If at any time ground water seepage is observed along the exposed excavation behind the retaining wall, contact the wall designer immediately to determine the corrective action needed.

The construction site should be graded and maintained to direct surface water runoff away from the retaining wall throughout the entire construction process. If there is a rain event with surface water runoff producing erosion or scour near the retaining wall, contact the wall designer immediately to determine the corrective action needed.

WATER APPLICATIONS

Due to the nature of wetcast concrete, the Rosetta Hardscape wall systems are well-suited for many shoreline and water applications. From small water features to custom ponds or where shoreline protection is needed, the wall systems can be implemented to provide the erosion control needed without sacrificing the natural aesthetic of your project.

Refer to the typical design details for more information. Once you've gathered the necessary details of the project, site conditions, and any local building requirements, reach out to your local Rosetta representative for further details.

ADDITIONAL INSTALLATION NOTES FOR:

- Outcropping
- Grand Ledge

Refer to product pages for specific information and details pertaining to individual products.

INSTALLATIONS REQUIRING GEOGRID

Please visit rosettahardscapes.com for detailed cross-sections of geogrid reinforced Outcropping walls. For Outcropping installations, do not overlap geogrid over top of blocks. Instead, run the geogrid directly up to the back of the blocks. In addition to this reinforcement, a Paraweb strap must be installed through each lifting hook in the back of the Outcropping blocks. Please see standard details for Reinforced Outcropping Walls for further information.

Place and compact drainstone and reinforced fill following the procedure used to set the bottom and upper courses of blocks. It is important to place and compact stone and reinforced fill starting at the back of the retaining blocks and extending into the reinforced soil zone. This will help eliminate inbunching of the geogrid reinforcement.

Reinforced zone fill material is typically a sand or gravel with less than 5% fines in (material passing the No. 200 sieve). This material is usually classified as a GW, GP, SW, or SP. It is very important that you only use the fill material specified in your project design drawings and specifications.

Place retained soil immediately between the reinforced soil zone and the back of the excavation. Material should be placed in loose lifts of 6 in (150 mm) maximum and compacted to 95% maximum density as determined by a standard proctor test (ASTM D698). Bring the reinforced and retained soil up to grade at the same time. At no time should the elevation of the reinforced soil be more than 1 block higher than the retained soil.

Tracked construction equipment should not be used directly on the geogrid. A minimum of 6 in (150 mm) of fill is required between tracked equipment and geogrid to prevent damage to the grid. Rubber-tired equipment may pass over the geogrid when traveling at low speeds of 5 mph (8 km/h) or less.

Avoid any sudden stopping or turning of construction equipment in the reinforced fill zone to prevent moving or damaging the geogrid layers.

Follow geogrid manufacturer's requirements, including requirements for vertical separation and overlap of geogrid.

FOR ALL INSTALLATIONS

Never stack blocks more than one course above grade of backfill.



OUTCROPPING OFFSETS BY HEIGHT OF BLOCK

One of the unique features of the Outcropping system is multiple block heights. To provide a uniform wall batter with multiple height blocks, the setback of the blocks varies proportionally with the block height. The setback in blocks is achieved with shear heels which are cast into the blocks. For a 6 in (152 mm) high block, the shear heels are 1.5 in (38 mm) deep (1/2 times 3 in (76 mm)). For a 12 in (305 mm) high block, the shear heels are 3 in (76 mm) deep (1 times 3 in (76 mm)). For an 18 in (457 mm) high block, the shear heels are 4.5 in (114 mm) deep (1-1/2 times 3 in (76 mm)). For a 24 in (610 mm) high block, the shear heels are 6 in (152 mm) deep (2 times 3 in (76 mm)).

To ensure proper wall alignment and to account for the multiple height blocks and varying setbacks, you have to adjust the bottom row of blocks based on their height. Setup a traditional string line for the back of the wall, then offset the blocks per the detail at the bottom of this page.

Outcropping / Grand Ledge lifting device required for proper installation.



OUTCROPPING OFFSET BY HEIGHT ILLUSTRATION

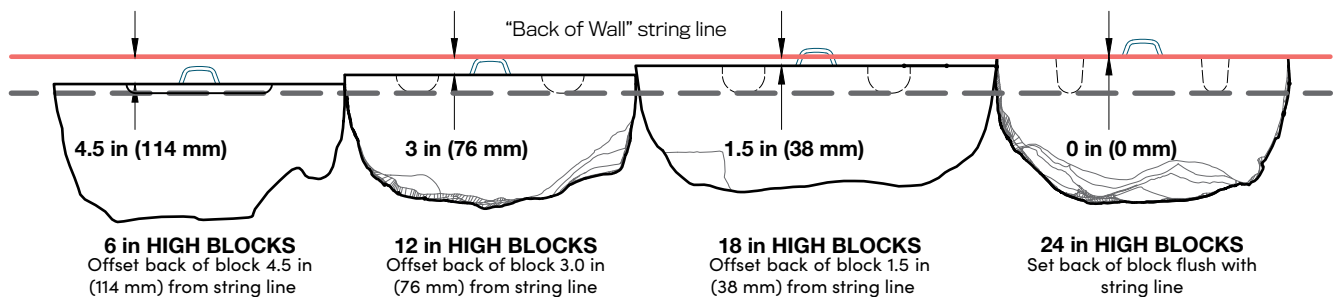



OUTCROPPING

FEATURES

- Beautiful weathered stone textures and natural color blends
- Consistent dimensions equals fast installation
- Quality materials equals long term durability
- Freestanding units have five-sided surface texture to allow for freestanding (two-sided) installations
- Corner blocks help make a 90° corner with five-sided surface texture and can be installed with alternating faces exposed to maintain a more random look
- Galvanized steel hooks are available and required for reinforced walls.

FOR PRELIMINARY WALL SECTIONS SCAN HERE



Notes:

- *Colors & product availability vary by region.
- **Outcropping pallets are sold in full pallet quantities only, individual sizes cannot be requested. Actual weight and color may vary.

CORNER PALLET: 6 in (152 mm)

Weight: ±2,015 lb (±914 kg) (inc. pallet)

Coverage: 11 sq ft (1.02 sq m)

Units Per Pallet: 4

Product depth nominally
27 in (686 mm)



UNIT: CORNER 6 in (152 mm)

Weight: ±480 lb (±218 kg)

CORNER PALLET: 12 in (305 mm)

Weight: ±3,600 lb (±1,633 kg) (inc. pallet)

Coverage: 19.5 sq ft (1.81 sq m)

Units Per Pallet: 3

Product depth nominally
30 in (762 mm)



UNIT: CORNER 12 in (305 mm)

Weight: ±1,170 lb (±531 kg)

CORNER NOTES

- Two 6 in (152 mm) high corner blocks are typically stacked on top of each other and placed on top of a 12 in (305 mm) block.
- In a few areas, you may need to trim a small part of the corner blocks near the back of the wall to avoid interference with the shear heels on adjacent blocks.

OUTCROPPING

RETAINING PALLET: A

Weight: ±4,000 lb (±1,814 kg) (inc. pallet)
 Coverage : 18 sq ft (1.67 sq m)
 Units Per Pallet: 4 (1 of each)



UNIT: 42 x 12 in (1068 x 305 mm)
 Weight: ±750 lb (±340 kg)



UNIT: 48 x 12 in (1219 x 305 mm)
 Weight: ±900 lb (±408 kg)



UNIT: 60 x 12 in (1524 x 305 mm)
 Weight: ±1,100 lb (±499 kg)



UNIT: 66 x 12 in (1676 x 305 mm)
 Weight: ±1,150 lb (±522 kg)

Product depth nominally from 18 in (457 mm) – 24 in (610 mm) for Retaining Wall units.

RETAINING PALLET: B

Weight: ±4,000 lb (±1,814 kg) (inc. pallet)
 Coverage : 18 sq ft (1.67 sq m)
 Units Per Pallet: 6 (1 of each)



UNIT: 24 x 6 in (610 x 152 mm)
 Weight: ±250 lb (±113 kg)



UNIT: 36 x 6 in (914 x 152 mm)
 Weight: 320± lb (±145 kg)



UNIT: 48 x 6 in (1219 x 152 mm)
 Weight: ±450 lb (±204 kg)



UNIT: 36 x 12 in (914 x 305 mm)
 Weight: ±620 lb (±281 kg)



UNIT: 54 x 12 in (1372 x 305 mm)
 Weight: 950± lb (±430 kg)



UNIT: 72 x 12 in (1829 x 305 mm)
 Weight: ±1,300 lb (±589 kg)

Product depth nominally from 18 in (457 mm) – 24 in (610 mm) for Retaining Wall units.

RETAINING PALLET: C

Weight: ±4,000 lb (±1,814 kg) (inc. pallet)
 Coverage : 18 sq ft (1.67 sq m)
 Units Per Pallet: 4 (1 of each)



UNIT: 24 x 6 in (610 x 152 mm)
 Weight: ±250 lb (±113 kg)



UNIT: 36 x 6 in (914 x 152 mm)
 Weight: ±320 lb (±145 kg)



UNIT: 60 x 18 in (1524 x 457 mm)
 Weight: ±1,600 lb (±726 kg)



UNIT: 48 x 24 in (1219 x 610 mm)
 Weight: ±1,800 lb (±816 kg)

Product depth nominally from 18 in (457 mm) – 24 in (610 mm) for Retaining Wall units.

FREESTANDING PALLET: D

Weight: ±3,150 lb (±1,429 kg) (inc. pallet)
 Coverage: 11 sq ft (1.02 sq m)
 Units Per Pallet: 3 (1 of each)



UNIT: 48 x 12 in (1219 x 305 mm)
 Weight: ±1,080 lb (±490 kg)



UNIT: 48 x 6 in (1219 x 152 mm)
 Weight: ±460 lb (±209 kg)



UNIT: 60 x 12 in (1524 x 305 mm)
 Weight: ±1,540 lb (±699 kg)

Product depth nominally 30 in (762 mm) for Freestanding Wall units.

FREESTANDING PALLET: E

Weight: ±3,450 lb (±1,565 kg) (inc. pallet)
 Coverage: 10.5 sq ft (0.97 sq m)
 Units Per Pallet: 3 (1 of each)



UNIT: 36 x 12 in (914 x 305 mm)
 Weight: ±880 lb (±400 kg)



UNIT: 36 x 6 in (914 x 152 mm)
 Weight: ±440 lb (±200 kg)



UNIT: 72 x 12 in (1829 x 305 mm)
 Weight: ±2,080 lb (±943 kg)

Product depth nominally 30 in (762 mm) for Freestanding Wall units.

OUTCROPPING

RETAINING WALL PATTERNS, 90 sq ft (27 sq m)

(2 PALLET A, 2 PALLET B AND 1 PALLET C)

Please note that the length dimensions shown for Outcropping blocks are rounded for reference. The actual length of the constructed wall will vary slightly from the pattern dimensions shown. Block size and placement shown are for reference only. Individual Outcropping blocks will vary with installation pattern. For more information visit rosettahardscapes.com

45 ft X 2 ft (13.7 X 0.60 m)

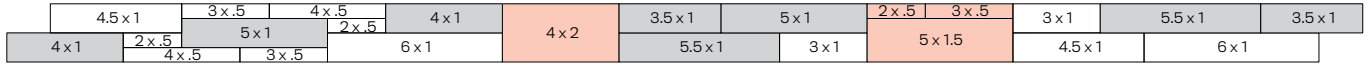

30 ft X 3 ft (9.14 X 0.91 m)

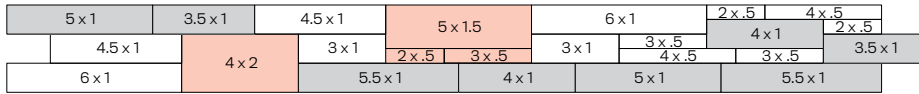

22.5 ft X 4 ft (6.85 X 1.21 m)

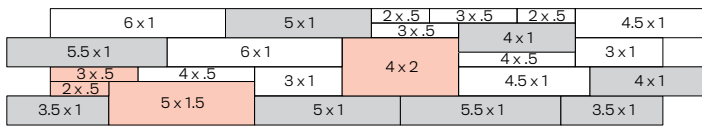

18 ft X 5 ft (5.48 X 1.52 m)

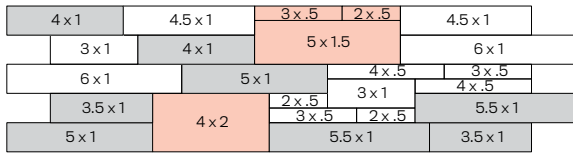

90° CORNER WALL

Outcropping has two corner blocks to help make a 90° corner in the wall. The corner blocks are four-sided, and can be installed with alternating faces exposed to maintain a more random look.

The size of the corner blocks have been chosen to account for the wall batter in both directions. Two 6 in (152 mm) high corner blocks are typically stacked on top of each other and placed on top of a 12 in (305 mm) block. The corner blocks are intended to be stepped back 3 in (76 mm) in both directions. In a few areas, you may need to trim a small part of the corner blocks near the back of the wall to avoid interference with the shear heels on adjacent blocks. See the pattern shown here, which details how to make a 90° corner with (4) A pallets, (4) B pallets, (2) C pallets, (3) 12 in (305 mm) corner blocks and (4) 6 in (152 mm) corner blocks.

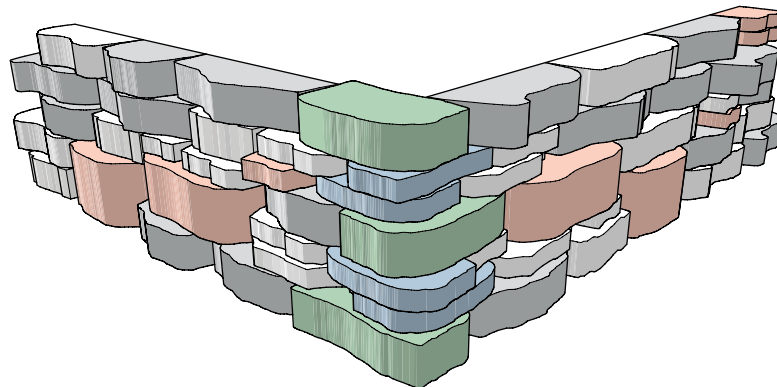
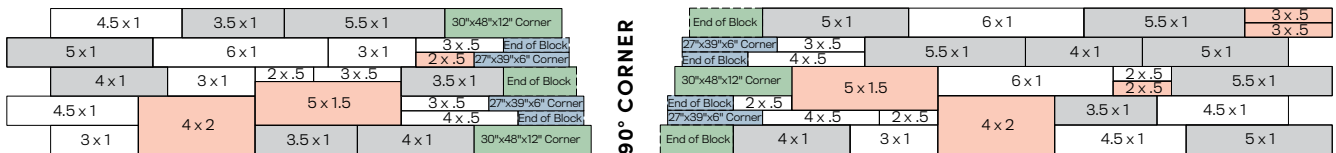

CURVES

Outcropping blocks have shear heels to help with wall integrity and provide a setback from lower blocks in the wall, thus causing the wall to batter back. The batter is important to the engineering design of the wall, and it must be accounted for during construction of a curved wall section.

OUTSIDE (CONVEX) CURVE

If you are constructing an outside (convex) curve, the wall batter will cause the blocks higher in the wall to have a shorter radius around the curve than lower blocks. This will cause the higher blocks to ingrow in the wall layout pattern. (This is similar in concept to the inside lane of a race track being shorter than the outside lane). The result is a potential overlap between some of the blocks in the wall. The best way to deal with this overlap is to saw cut the end of the smaller block, which allows the blocks to fit tight together and all the shear heels to be properly engaged. This saw cut is typically made on an angle to match the taper on the block you are abutting.

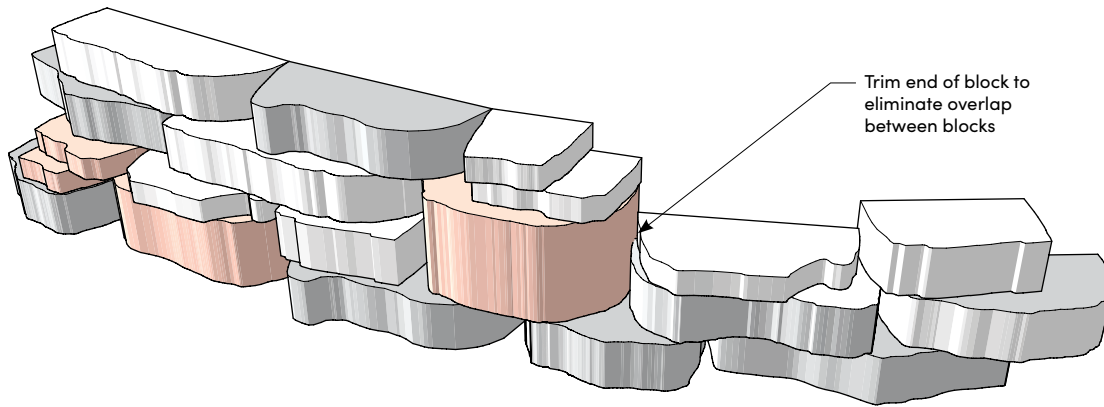

INSIDE (CONCAVE) CURVE

If you are constructing an inside (concave) curve, the wall batter will cause the block higher in the wall to have a longer radius around the curve than lower blocks. The important step when constructing an inside curve is to keep all blocks tight together. In most cases, the blocks will touch somewhere along the sides of the blocks, not at the back of the blocks. If needed, you can trim the ends off some blocks to prevent gaps from opening up between blocks. When constructing a curve with a short radius, voids may form at the back of the wall where two blocks meet. If this happens simply fill the void areas with filter fabric and drainstone.

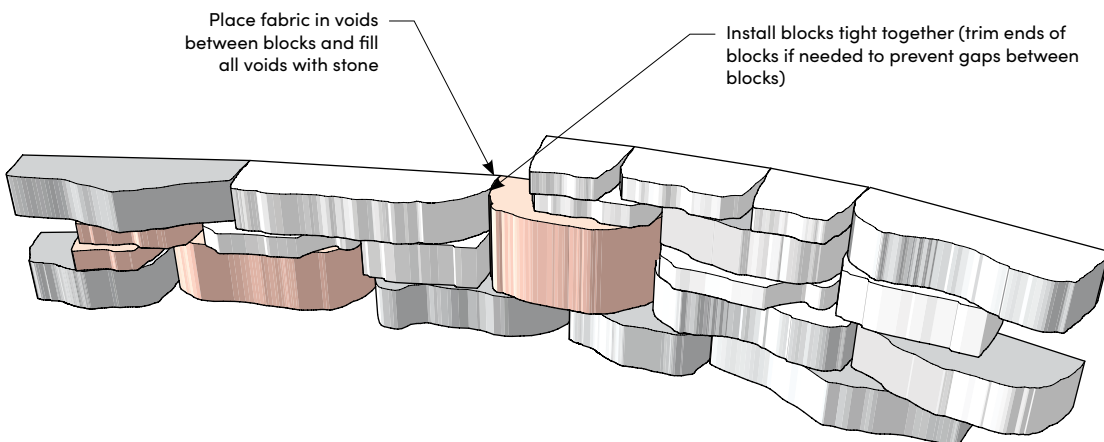

GENERAL NOTES FOR WALL SECTIONS

This page shows typical construction details for Outcropping walls. These drawings are representative of major components required in wall construction. Specific details including geotextile reinforcement layers, drainage details, soil requirements, etc. shall be per engineered design for the wall. For more cross-section and design options, visit our website.

- These drawings are for preliminary reference only (not for final construction).
- Final designs for construction must be prepared by a registered professional engineer using the actual conditions of the proposed site and loads.
- Block size and placement shown are for reference only, individual Outcropping blocks will vary with installation pattern.

TYPICAL FREESTANDING WALL DETAIL

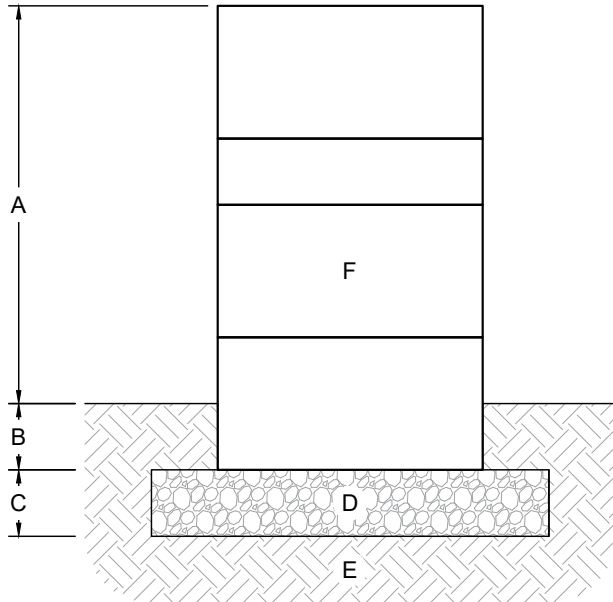

- A. Exposed height (varies, max. 36 in (1067 mm))
- B. Bury depth (min. 6 in (152 mm))
- C. Leveling pad depth (min. 6 in (152 mm))
- D. Crushed stone leveling pad
- E. Foundation soil compacted to 95% max. dry density
- F. Freestanding wall blocks

TYPICAL GRAVITY RETAINING WALL DETAIL

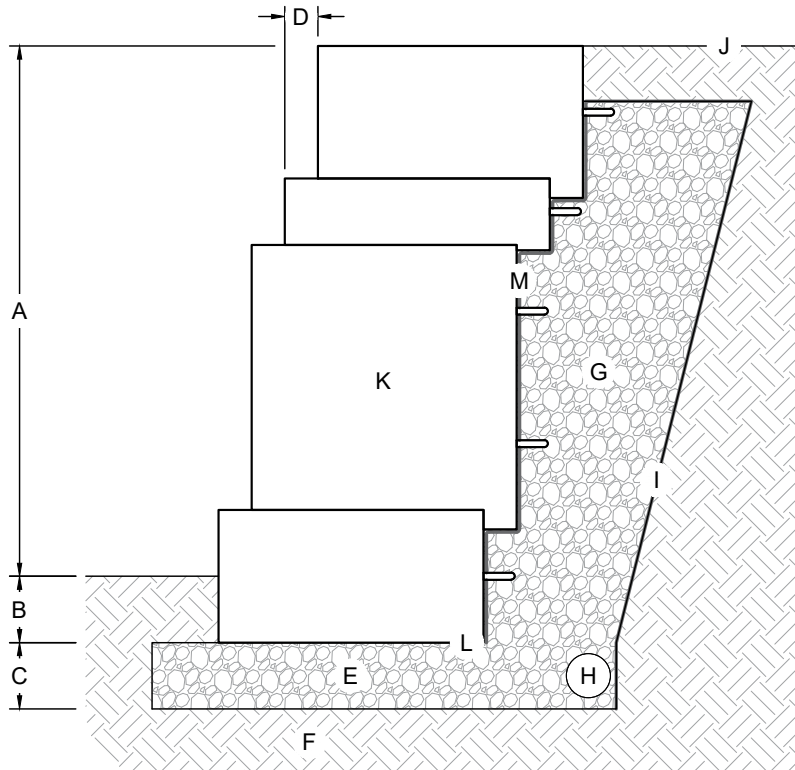

- A. Exposed height (varies by design)
- B. Bury depth (varies by design, min. 6 in (152 mm))
- C. Leveling pad depth (varies by design, min. 6 in (152 mm))
- D. Horizontal setback, 3 in (76 mm) per 12 in (305 mm) vertical (14° batter angle on wall)
- E. Crushed stone leveling pad
- F. Foundation soil compacted to 95% max. dry density
- G. Drainstone (ASTM #57) min. 12 in (305 mm) behind wall
- H. 4 in (102 mm) corrugated perforated drain pipe
- I. Non-woven geotextile fabric
- J. Finish grade to drain away from the wall
- K. Wall blocks
- L. Shear heel removed from base block (optional)
- M. Non-woven geotextile fabric at back of blocks and top of drainstone (required)

GENERAL NOTES FOR WALL SECTIONS

This page shows typical construction details for Outcropping walls. These drawings are representative of major components required in wall construction. Specific details including geotextile reinforcement layers, drainage details, soil requirements, etc. shall be per engineered design for the wall. For more cross-section and design options, visit our website.

- These drawings are for preliminary reference only (not for final construction).
- Final designs for construction must be prepared by a registered professional engineer using the actual conditions of the proposed site and loads.
- Block size and placement shown are for reference only, individual Outcropping blocks will vary with installation pattern.

TYPICAL RETAINING WALL DETAIL WITH SOIL REINFORCEMENT

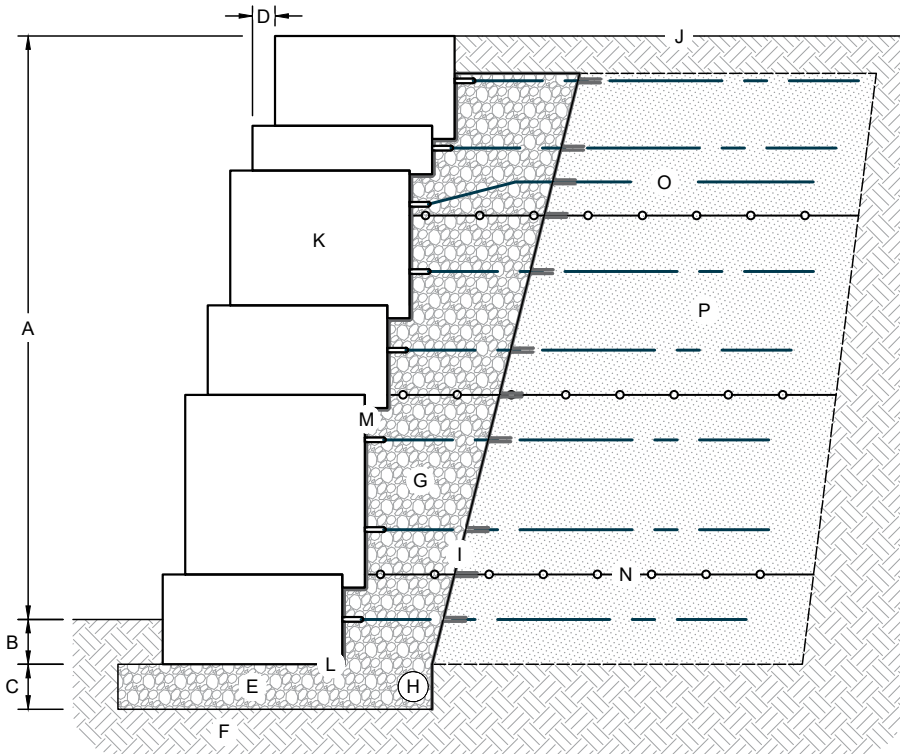

- A. Exposed height (varies by design)
- B. Bury depth (varies by design, min. 6 in (152 mm))
- C. Leveling pad depth (varies by design, min. 6 in (152 mm))
- D. Horizontal setback, 3 in (76 mm) per 12 in (305 mm) vertical (14° batter angle on wall)
- E. Crushed stone leveling pad
- F. Foundation soil compacted to 95% max. dry density
- G. Drainstone (ASTM #57) min. 12 in (305 mm) behind wall
- H. 4 in (102 mm) corrugated perforated drain pipe
- I. Non-woven geotextile fabric (recommended)
- J. Finish grade to drain away from the wall
- K. Wall blocks
- L. Shear heel removed from base block (optional)
- M. Non-woven geotextile fabric at back of blocks and top of drainstone (required)
- N. Geogrid reinforcement, abutting the backside of the block (length, vertical placement, and geogrid type varies by design).
- O. Paraweb strap installed on every loop (embedment depth varies by design, maintain a min. 3 in (76 mm) vertical space from geogrid)
- P. Reinforced soil compacted to 95% max. dry density

GENERAL NOTES FOR WALL SECTIONS

This page shows typical construction details for Outcropping walls. These drawings are representative of major components required in wall construction. Specific details including geotextile reinforcement layers, drainage details, soil requirements, etc. shall be per engineered design for the wall. For more cross-section and design options, visit our website.

- These drawings are for preliminary reference only (not for final construction).
- Final designs for construction **must be prepared by a registered professional engineer using the actual conditions of the proposed site and loads.**
- Block size and placement shown are for reference only, individual Outcropping blocks will vary with installation pattern.

TYPICAL RETAINING WALL DETAIL WITH CAST-IN-PLACE CONCRETE BACKFILL

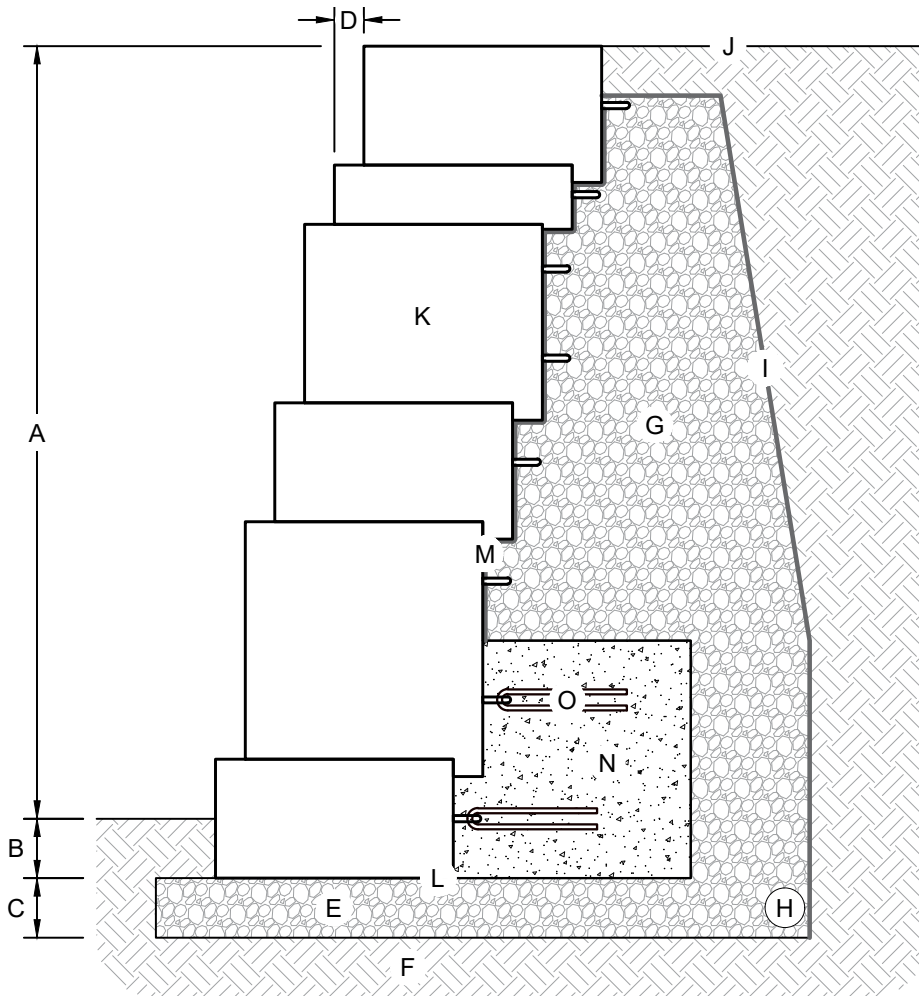

- A. Exposed height (varies by design)
- B. Bury depth (varies by design, min. 6 in (152 mm))
- C. Leveling pad depth (varies by design, min. 6 in (152 mm))
- D. Horizontal setback, 3 in (76 mm) per 12 in (305 mm) vertical (14° batter angle on wall)
- E. Crushed stone leveling pad
- F. Foundation soil compacted to 95% max. dry density
- G. Drainstone (ASTM #57) min. 12 in (305 mm) behind wall
- H. 4 in (102 mm) corrugated perforated drain pipe
- I. Non-woven geotextile fabric
- J. Finish grade to drain away from the wall
- K. Wall blocks
- L. Shear heel removed from base block (optional)
- M. Non-woven geotextile fabric at back of blocks and top of drainstone (required)
- N. Cast-in-place ready-mix concrete, min. 2,500 psi (17 MPa) (height & depth vary by design)
- O. #4 rebar, 18 in (457 mm) lengths ben in half (9 in (229 mm) embedment), installed on every loop.

GENERAL NOTES FOR WALL SECTIONS

This page shows typical construction details for Outcropping walls. These drawings are representative of major components required in wall construction. Specific details including geotextile reinforcement layers, drainage details, soil requirements, etc. shall be per engineered design for the wall. For more cross-section and design options, visit our website.

- These drawings are for preliminary reference only (not for final construction).
- Final designs for construction must be prepared by a registered professional engineer using the actual conditions of the proposed site and loads.
- Block size and placement shown are for reference only, individual Outcropping blocks will vary with installation pattern.

TYPICAL GRAVITY RETAINING WALL DETAIL WITH AGGREGATE WEDGE BACKFILL

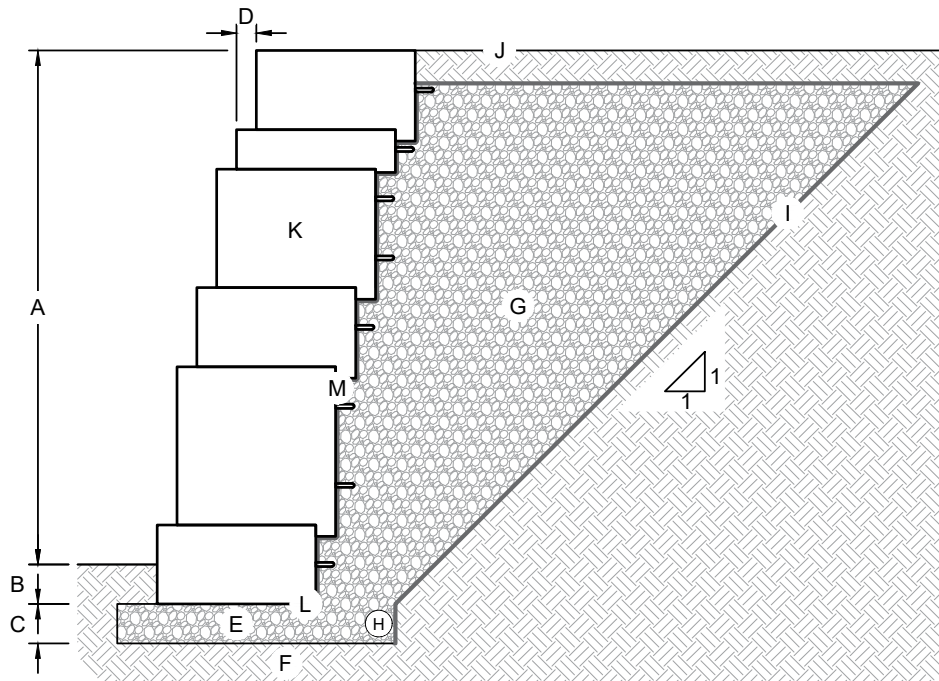

- A. Exposed height (varies by design)
- B. Bury depth (varies by design, min. 6 in (152 mm))
- C. Leveling pad depth (varies by design, min. 6 in (152 mm))
- D. Horizontal setback, 3 in (76 mm) per 12 in (305 mm) vertical (14° batter angle on wall)
- E. Crushed stone leveling pad
- F. Foundation soil compacted to 95% max. dry density
- G. Drainstone (ASTM #57) installed on 1H:1V slope behind wall
- H. 4 in (102 mm) corrugated perforated drain pipe
- I. Non-woven geotextile fabric
- J. Finish grade to drain away from the wall
- K. Wall blocks
- L. Shear heel removed from base block (optional)
- M. Non-woven geotextile fabric at back of blocks and top of drainstone (required)

GRS CHART

This page shows typical construction details for Outcropping walls. These drawings are representative of major components required in wall construction. Specific details including geotextile reinforcement layers, drainage details, soil requirements, etc. shall be per engineered design for the wall.

- These drawings are for preliminary reference only (not for final construction).
- Final designs for construction must be prepared by a registered professional engineer using the actual conditions of the proposed site and loads.
- Final wall design must address both internal and external drainage and shall be evaluated by the professional engineer who is responsible for the wall design.
- Block size and placement shown are for reference only, individual Outcropping blocks will vary with installation pattern.

TYPICAL GEOSYNTHETIC REINFORCED SOIL (GRS) RETAINING SECTION

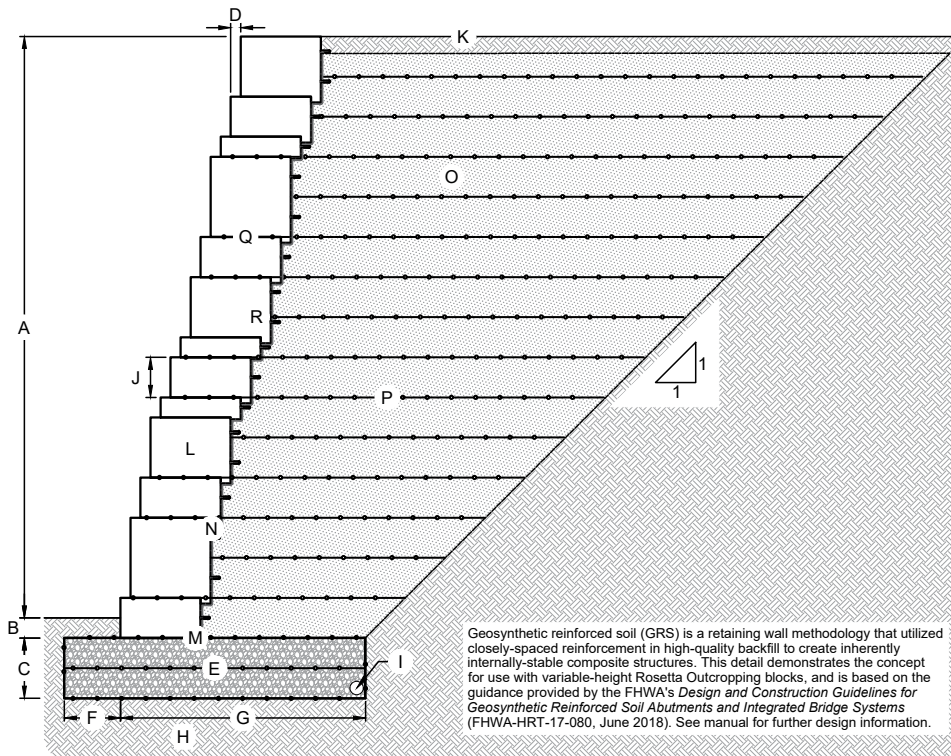

- A. Exposed height (varies by design)
- B. Bury depth (varies by design, min. 6 in (152 mm))
- C. Foundation depth, $C = 0.25 * F$ (varies by design)
- D. Horizontal setback, 3 in (76 mm) per 12 in (305 mm) vertical (14° batter angle on wall)
- E. Reinforced soil foundation
- F. Foundation toe, $C = 0.25 * F$ (varies by design)
- G. Foundation base, $F = 0.3 * A$ (greater than or equal to 5 - 6 ft (1.52 - 1.83 m))
- H. Foundation soil compacted to 95% max. dry density, additional depth and width of reinforced soil foundation may be necessary due to soft soils. Consult with a geotechnical engineer to determine suitability.
- I. 4 in (102 mm) corrugated perforated drain pipe
- J. Reinforcement Spacing, $I = 12$ in (305 mm) max.
- K. Finish grade to drain away from the wall
- L. Wall blocks
- M. Shear heel removed from base block (optional)
- N. Non-woven geotextile fabric at back of blocks
- O. Well-graded or open-graded backfill, compact to min. 95% max. dry density
- P. Geosynthetic reinforcement (typical woven polypropylene with MARV strength of 4,800 lb/ft (70.05 kN/m)), extend to stable cut slope
- Q. Place reinforcement between blocks where possible.
- R. Trim reinforcement around blocks where necessary.



GRAND LEDGE

FEATURES

- The look of natural ledgestone: bold in scale, with consistent dimensions for faster installation
- 24 unique face textures
- Quality materials equals long term durability
- Six additional 5-sided blocks can be used as 90° returns
- Engineerable wall system with capabilities of 5-6 ft (1.5-1.8 m) gravity walls with optimal site conditions

FOR PRELIMINARY WALL SECTIONS
SCAN HERE



Notes:

*Colors & product availability vary by region.
Dimensions are nominal.
Specifications are subject to change.

WALL BLOCKS



UNIT: 36 in (914 mm)

Dimensions: 36 x 20 x 12 in (914 x 508 x 305 mm)
Weight: ±650 lb (±295 kg)
Units Per Pallet: 1



UNIT: 48 in (1219 mm)

Dimensions: 48 x 20 x 12 in (1219 x 508 x 305 mm)
Weight: ±865 lb (±392 kg)
Units Per Pallet: 1



UNIT: 60 in (1524 mm)

Dimensions: 60 x 20 x 12 in (1524 x 508 x 305 mm)
Weight: ±1,085 lb (±492 kg)
Units Per Pallet: 1



UNIT: 72 in (1829 mm)

Dimensions: 72 x 20 x 12 in (1829 x 508 x 305 mm)
Weight: ±1,300 lb (±590 kg)
Units Per Pallet: 1

FREESTANDING BLOCKS



FREESTANDING UNIT A:

Dimensions: 35¼ x 24¼ x 12 in (895 x 616 x 305 mm)
Weight: ±770 lb (±350 kg)
Units Per Pallet: 1



FREESTANDING UNIT B:

Dimensions: 42¾ x 19¾ x 12 in (1086 x 502 x 305 mm)
Weight: ±760 lb (±345 kg)
Units Per Pallet: 1



FREESTANDING UNIT C:

Dimensions: 46 x 21 x 12 in (1168 x 533 x 305 mm)
Weight: ±880 lb (±395 kg)
Units Per Pallet: 1



FREESTANDING UNIT D:

Dimensions: 50½ x 25½ x 12 in (1283 x 648 x 305 mm)
Weight: ±1,160 lb (±525 kg)
Units Per Pallet: 1



FREESTANDING UNIT E:

Dimensions: 36 x 20 x 12 in (914 x 508 x 305 mm)
Weight: ±625 lb (±283 kg)
Units Per Pallet: 1



FREESTANDING UNIT F:

Dimensions: 54 x 20 x 12 in (1372 x 508 x 305 mm)
Weight: ±965 lb (±437 kg)
Units Per Pallet: 1

GENERAL NOTES FOR WALL SECTIONS

This page shows typical construction details for Grand Ledge walls. These drawings are representative of major components required in wall construction. Specific details including geotextile reinforcement layers, drainage details, soil requirements, etc. shall be per engineered design for the wall. For more cross-section and design options, visit our website.

- These drawings are for preliminary reference only (not for final construction).
- Final designs for construction **must be prepared by a registered professional engineer using the actual conditions of the proposed site and loads.**
- Final wall design must address both internal and external drainage and shall be evaluated by the professional engineer who is responsible for the wall design.
- Block size and placement shown are for reference only, individual Grand Ledge blocks will vary with installation pattern.

TYPICAL GRAVITY RETAINING WALL DETAIL

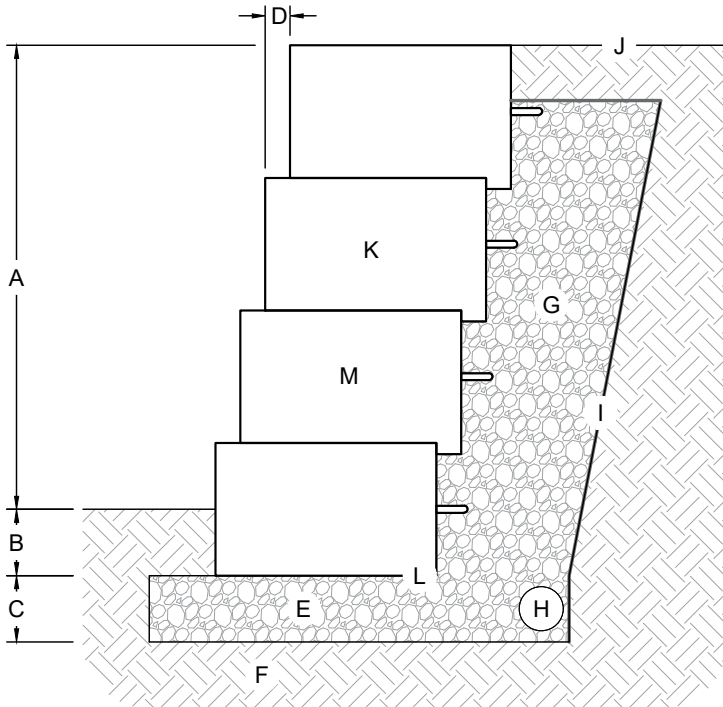

- A. Exposed height (varies by design)
- B. Bury depth (varies by design, min. 6 in (152 mm))
- C. Leveling pad depth (varies by design, min. 6 in (152 mm))
- D. Horizontal setback, 2-1/4 in (57 mm) per 12 in (305 mm) vertical (10.6° batter angle on wall)
- E. Crushed stone leveling pad
- F. Foundation soil compacted to 95% max. dry density
- G. Drainstone (ASTM #57) min. 12 in (305 mm) behind wall
- H. 4 in (102 mm) corrugated perforated drain pipe
- I. Non-woven geotextile fabric
- J. Finish grade to drain away from the wall
- K. Wall blocks
- L. Shear heel removed from base block (optional)
- M. Place 12 in (305 mm) by 18 in (457 mm) strip of geotextile fabric in V-shaped joint between blocks

TYPICAL FREESTANDING WALL DETAIL

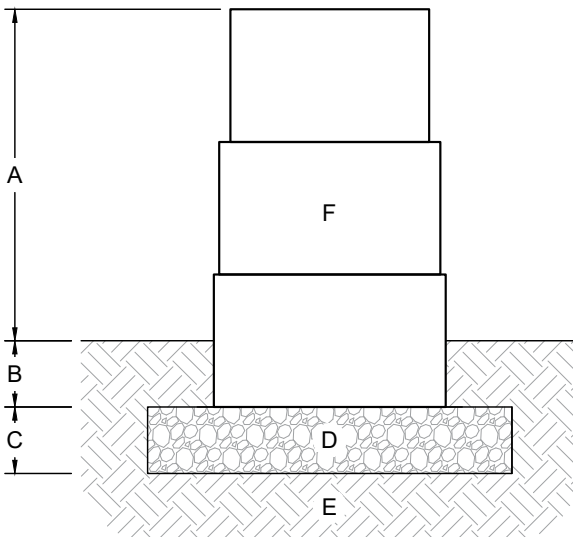

- A. Exposed height (varies, max. 24 in (610 mm))
- B. Bury depth (min. 6 in (152 mm))
- C. Leveling pad depth (min. 6 in (152 mm))
- D. Crushed stone leveling pad
- E. Foundation soil compacted to 95% max. dry density
- F. Freestanding wall blocks

GENERAL NOTES FOR WALL SECTIONS

This page shows typical construction details for Grand Ledge walls. These drawings are representative of major components required in wall construction. Specific details including reinforcement layers, drainage details, soil requirements, etc. shall be per engineered design for the wall. For more cross-section and design options, visit our website.

- These drawings are for preliminary reference only (not for final construction).
- Final designs for construction must be prepared by a registered professional engineer using the actual conditions of the proposed site and loads.

TYPICAL GRAVITY RETAINING WALL DETAIL WITH AGGREGATE WEDGE BACKFILL

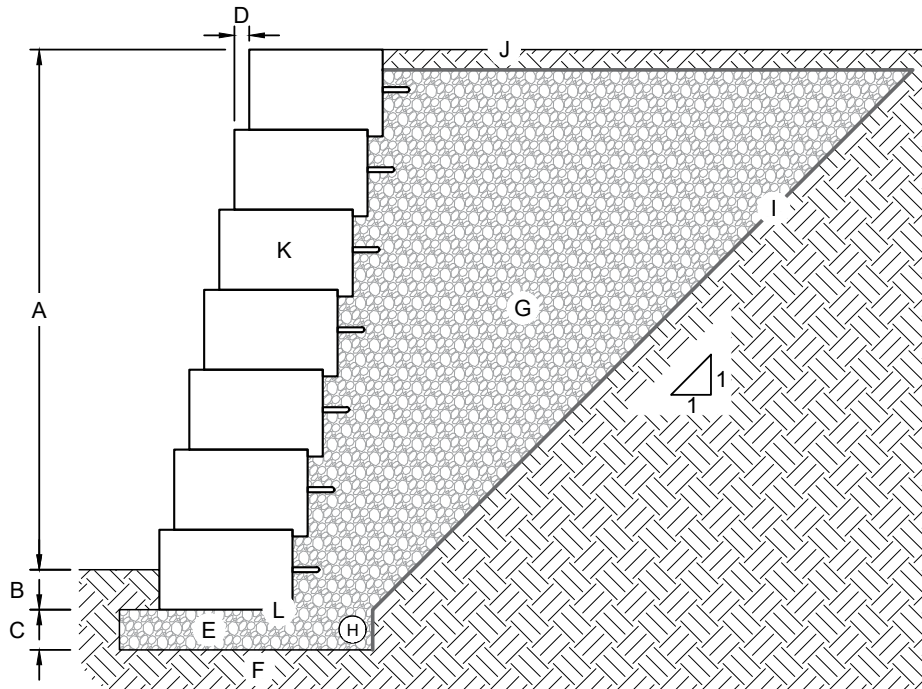

- A. Exposed height (varies by design)
- B. Bury depth (varies by design, min. 6 in (152 mm))
- C. Leveling pad depth (varies by design, min. 6 in (152 mm))
- D. Horizontal setback, 2- 1/4 in (57 mm) per 12 in (305 mm) vertical (10.6° batter angle on wall)
- E. Crushed stone leveling pad
- F. Foundation soil compacted to 95% max. dry density
- G. Drainstone (ASTM #57) installed on 1H:1V slope behind wall
- H. 4 in (102 mm) corrugated perforated drain pipe
- I. Non-woven geotextile fabric
- J. Finish grade to drain away from the wall
- K. Wall blocks
- L. Shear heel removed from base block (optional)

TYPICAL RETAINING WALL DETAIL WITH CAST-IN-PLACE CONCRETE BACKFILL

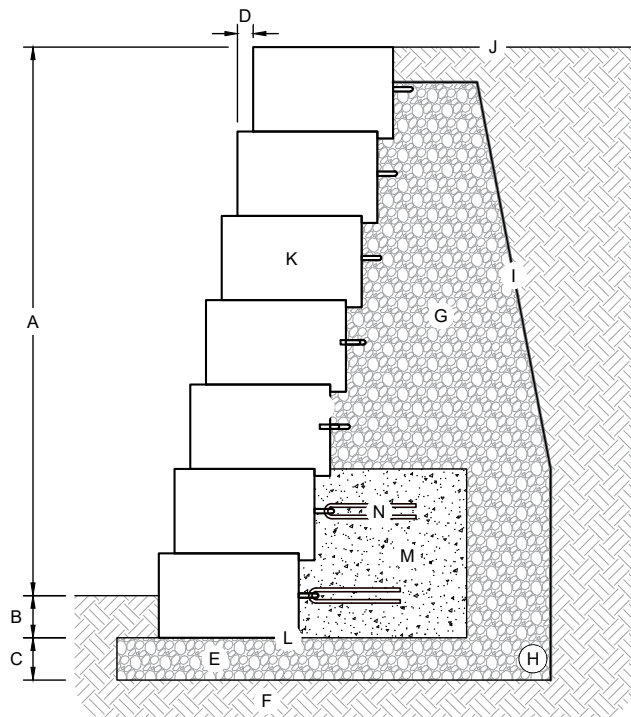

- A. Exposed height (varies by design)
- B. Bury depth (varies by design, min. 6 in (152 mm))
- C. Leveling pad depth (varies by design, min. 6 in (152 mm))
- D. Horizontal setback, 2- 1/4 in (57 mm) per 12 in (305 mm) vertical (10.6° batter angle on wall)
- E. Crushed stone leveling pad
- F. Foundation soil compacted to 95% max. dry density
- G. Drainstone (ASTM #57) min. 12 in (305 mm) behind wall
- H. 4 in (102 mm) corrugated perforated drain pipe
- I. Non-woven geotextile fabric
- J. Finish grade to drain away from the wall
- K. Wall blocks
- L. Shear heel removed from base block (optional)
- M. Cast-in-place ready-mix concrete, min. 2,500 psi (17 MPa) (height & depth vary by design)
- N. #4 rebar, 18 in (457 mm) lengths bent in half (9 in (229 mm) embedment), installed on every loop

GENERAL NOTES FOR WALL SECTIONS

This page shows typical construction details for Grand Ledge walls. These drawings are representative of major components required in wall construction. Specific details including geotextile reinforcement layers, drainage details, soil requirements, etc. shall be per engineered design for wall. For more cross-section and design options, visit our website.

- These drawings are for preliminary reference only (not for final construction).
- Final designs for construction **must be prepared by a registered professional engineer using the actual conditions of the proposed site and loads.**
- Final wall design must address both internal and external drainage and shall be evaluated by the professional engineer who is responsible for the wall design.
- Block size and placement shown are for reference only, individual Grand Ledge blocks will vary with installation pattern.

TYPICAL REINFORCED RETAINING WALL DETAIL

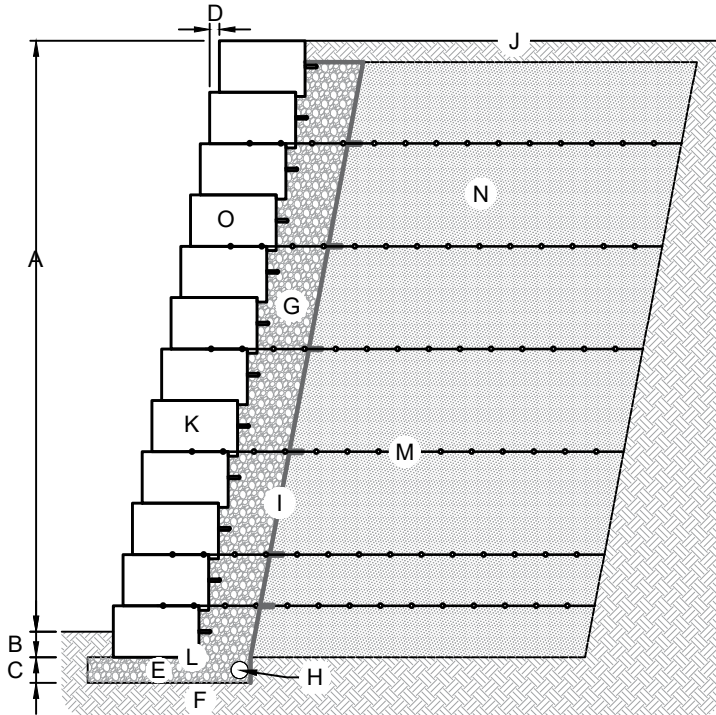

- A. Exposed height (varies by design)
- B. Bury depth (varies by design, min. 6 in (152 mm))
- C. Leveling pad depth (varies by design, min. 6 in (152 mm))
- D. Horizontal setback, 2-1/4 in (57 mm) per 12 in (305 mm) vertical (10.6° batter angle on wall)
- E. Crushed stone leveling pad
- F. Foundation soil compacted to 95% max. dry density
- G. Drainstone (ASTM #57) min. 12 in (305 mm) behind wall
- H. 4 in (102 mm) corrugated perforated drain pipe
- I. Non-woven geotextile fabric
- J. Finish grade to drain away from the wall
- K. Wall blocks
- L. Shear heel removed from base block (optional)
- M. Geogrid reinforcement placed between blocks (length, vertical placement, and geogrid type varies by design)
- N. Reinforced soil compacted to 95% max. dry density
- O. Place 12" (305 mm) by 18" (457 mm) strip of geotextile fabric in V-shaped joint between blocks

GRS CHART

This page shows typical construction details for Grand Ledge walls. These drawings are representative of major components required in wall construction. Specific details including geotextile reinforcement layers, drainage details, soil requirements, etc. shall be per engineered design for wall.

- These drawings are for preliminary reference only (not for final construction).
- Final designs for construction must be prepared by a registered professional engineer using the actual conditions of the proposed site and loads.
- Final wall design must address both internal and external drainage and shall be evaluated by the professional engineer who is responsible for the wall design.
- Block size and placement shown are for reference only, individual Grand Ledge blocks will vary with installation pattern.

TYPICAL GEOSYNTHETIC REINFORCED SOIL (GRS) RETAINING SECTION

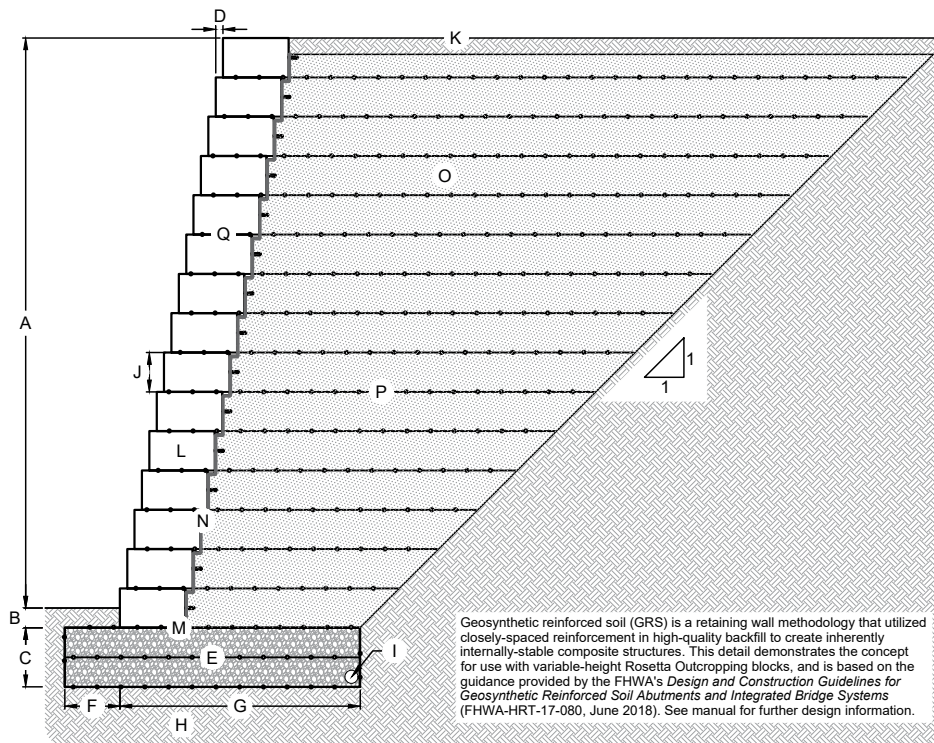

- A. Exposed height (varies by design)
- B. Bury depth (varies by design, min. 6 in (152 mm))
- C. Foundation depth, $C = 0.25 * F$ (varies by design)
- D. Horizontal setback, 2- 1/4 in (57 mm) per 12 in (305 mm) vertical (10.6° batter angle on wall)
- E. Reinforced soil foundation
- F. Foundation toe, $C = 0.25 * F$ (varies by design)
- G. Foundation base, $F = 0.3 * A$ (greater than or equal to 5 - 6 ft (1.52 - 1.83 m))
- H. Foundation soil compacted to 95% max. dry density, additional depth and width of reinforced soil foundation may be necessary due to soft soils. Consult with a geotechnical engineer to determine suitability.
- I. 4 in (102 mm) corrugated perforated drain pipe
- J. Reinforcement Spacing, $I = 12$ in (305 mm) max.
- K. Finish grade to drain away from the wall
- L. Wall blocks
- M. Shear heel removed from base block (optional)
- N. Non-woven geotextile fabric at back of blocks
- O. Well-graded or open-graded backfill, compact to min. 95% max. dry density
- P. Geosynthetic reinforcement (typical woven polypropylene with MARV strength of 4,800 lb/ft (70.05 kN/m)), extend to stable cut slope
- Q. Place reinforcement between blocks.

BELVEDERE

FEATURES

- Natural stone texture on both the front and back with multiple face textures for each basic block size to provide a more random look
- Creates both freestanding and retaining walls
- Walls, columns, fire pits and more mean multiple creative possibilities
- Wall blocks are tapered on each side approximately 1 in (25 mm) from the front to the back of the block
- Corner blocks are finished on three sides, the fourth side is tapered to fit with the wall blocks
- Corner blocks can be used to construct columns, create finished ends for walls, and make 90° corners
- Belvedere caps and coping available to coordinate with wall product

FOR PRELIMINARY WALL SECTIONS SCAN HERE



Notes:

*Colors & product availability vary by region.
Average block weights of the different face textures patterns are shown. Weights of individual blocks may vary.

WALL PALLET



Product depth nominally 9 in (229 mm)

Weight: ±2,475 lb (±1,123 kg) (inc. pallet)
 Coverage (Retaining): 27 sq ft (8.2 sq m)
 Coverage (Freestanding): 25 sq ft (7.6 sq m)
 Layers Per Pallet: 6
 Section: 9 sq ft (2.7 sq m) per 2 layers (1 layer of 6 in (152 mm), 1 layer of 3 in (76 mm))

UNIT: 1 L x W x H
 Dimensions: 6 x 9 x 3 in (152 x 229 x 76 mm)
 Weight: ±10 lb (±5 kg)
 Units Per Pallet: 12

UNIT: 2
 Dimensions: 12 x 9 x 3 in (305 x 229 x 76 mm)
 Weight: ±20 lb (±9 kg)
 Units Per Pallet: 12

UNIT: 3
 Dimensions: 18 x 9 x 3 in (457 x 229 x 76 mm)
 Weight: ±36 lb (±16 kg)
 Units Per Pallet: 12

UNIT: 4
 Dimensions: 6 x 9 x 6 in (152 x 229 x 152 mm)
 Weight: 21± lb (10± kg)
 Units Per Pallet: 12

UNIT: 5
 Dimensions: 12 x 9 x 6 in (305 x 229 x 152 mm)
 Weight: ±42 lb (±19 kg)
 Units Per Pallet: 12

UNIT: 6
 Dimensions: 18 x 9 x 6 in (457 x 229 x 152 mm)
 Weight: ±67 lb (±30 kg)
 Units Per Pallet: 12

CORNER PALLET



Product depth nominally 9 in (229 mm)

Weight: ±1,520 lb (±690 kg) (inc. pallet)
 Coverage: 24 sq ft (7.3 sq m)
 Layers Per Pallet: 4
 Section: 1.5 sq ft (0.5 sq m) (one 6 in (152 mm) piece, one 3 in (76 mm) piece)

UNIT: 7 L x W x H
 Dimensions: 15 x 9 x 3 in (381 x 229 x 76 mm)
 Weight: ±30 lb (±14 kg)
 Units Per Pallet: 16

UNIT: 8
 Dimensions: 15 x 9 x 6 in (381 x 229 x 152 mm)
 Weight: ±58 lb (±26 kg)
 Units Per Pallet: 16

RETAINING WALL PATTERNS

Retaining walls are typically constructed with the front face of the block exposed. The v-shaped notches which appear on the back of wall between adjacent blocks must be filled with drainstone. The blocks shown below are labeled. For example, 4F would indicate the front (or longer) face of Unit 4, and 2B would indicate the back (or shorter) face of Unit 2.

12 in (3.65 m) HIGH

(12 in (305 mm) high x 13 ft-6 in (4 m-152 mm) wall section shown = 13.5 sq ft (4.1 sq m) (1/2 wall pallet)

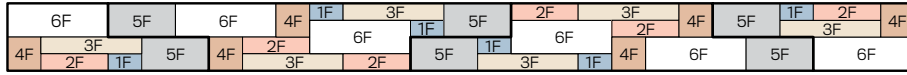

FACE OF WALL



BACK OF WALL

(Drainstone behind and between blocks)

18 in (5.48 m) HIGH

(12 in (305 mm) high x 18 ft-0 in (5 m-0 mm) wall section shown = 27 sq ft (8 sq m) (1 wall pallet)

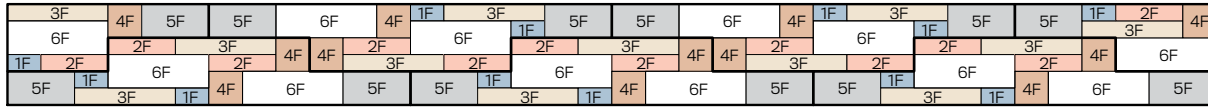

24 in (7.31 m) HIGH

(24 in high x 16 ft-0 in wall section shown = 32 sq ft (9.75 m) (1.2 wall pallet)

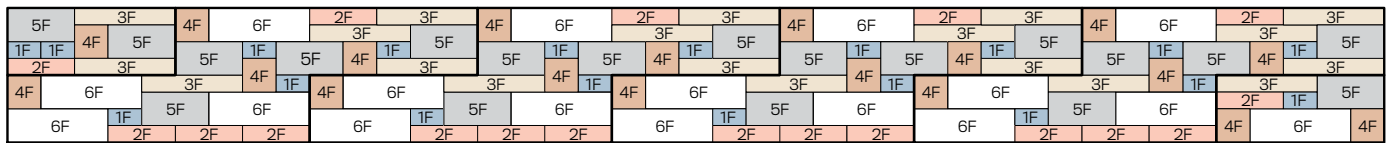

FREESTANDING WALL PATTERNS

24 in (3.65 m) PATTERN A

(Wall section shown = 24.67 sq ft (7.51 sq m) (approx. 1 wall pallet)

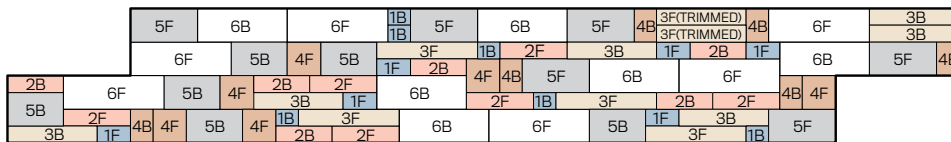

FACE OF WALL

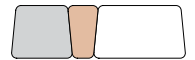

FACE OF WALL

Note: 2 in (51 mm) must be trimmed from (2) 18 in X 3 in (457 x 76 mm) blocks to make this pattern

24 in (7.31 m) PATTERN B

(Wall section shown = 24.67 sq ft (7.51 sq m) (approx. 1 wall pallet)

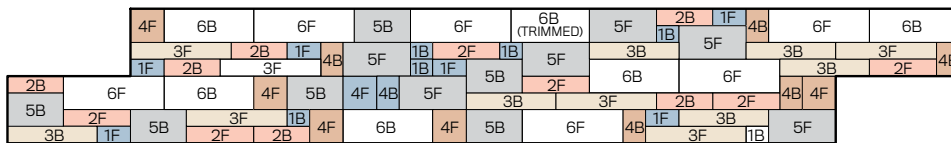

Note: 2 in (51 mm) must be trimmed from (1) 18 in X 6 in (457 x 152 mm) block to make this pattern

24 in (7.31 m) HIGH VERTICAL END: LEFT

(Wall section shown = 11.67 sq ft (3.55 sq m) (1/2 wall pallet)

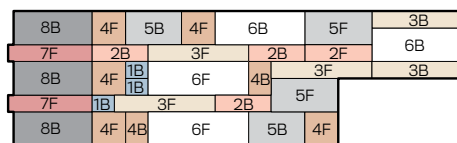

24 in (7.31 m) HIGH VERTICAL END: RIGHT

(Wall section shown = 11.67 sq ft (3.55 sq m) (1/2 wall pallet)

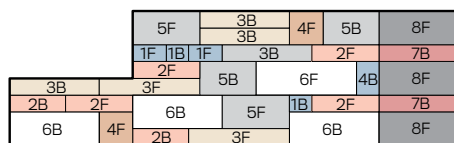

Note: For left and right ends, vertical end jogs in and out approximately 1 in (25 mm) between blocks.

RETAINING WALL CURVES

This page shows typical construction details for making curved retaining walls with Belvedere blocks. The taper on the side of the blocks allow for construction of a wide range of curves in both retaining and freestanding walls. Blocks in a retaining wall should be adjusted slightly in place and trimmed as needed to allow wall construction with proper batter. (For clarity, walls are shown below without batter.)

- Minimum radius curves are shown which can be constructed without saw cutting a significant number of blocks. Larger radius curves can be created by leaving a larger gap between blocks on the back side of the wall. The gaps must be filled with drainstone.
- When retaining walls are constructed with batter, the radius on outside curves becomes smaller with each course due to the block setback. For proper construction, the radius of the bottom course must be larger than the minimum radius so upper courses will have sufficient room for construction.
- When retaining walls are constructed with a batter, the radius on inside curves becomes larger with each course due to the block setback.

OUTSIDE CURVE

INSIDE CURVE

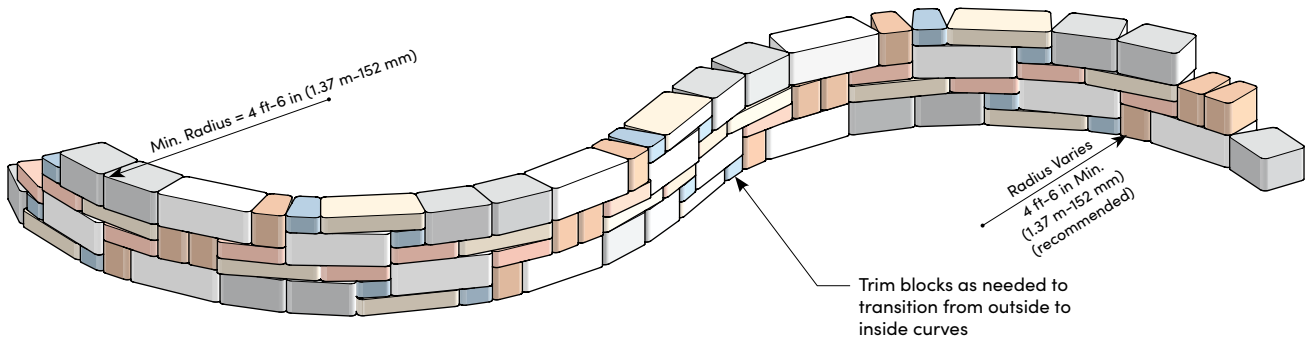

PLANTER / TREE RING

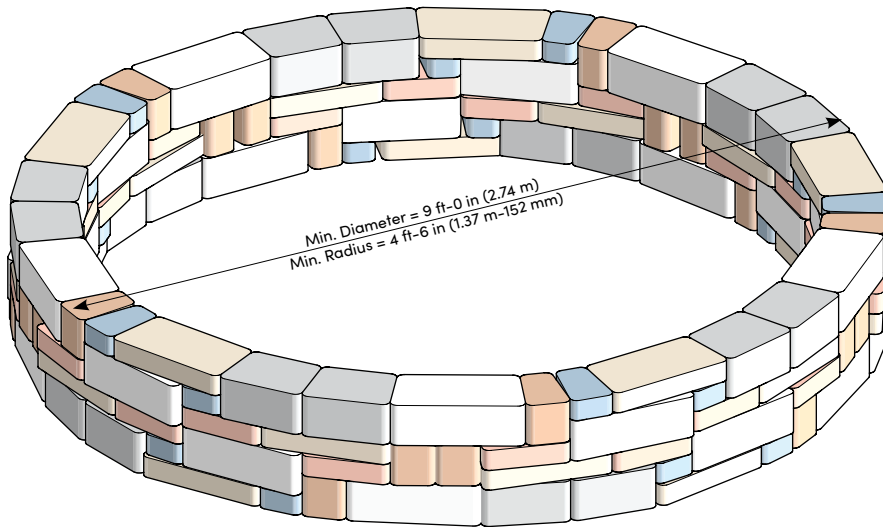

NOTE: CURVED FREESTANDING WALLS

Curved freestanding walls can also be built. Typically, the blocks have to be field adjusted to make the desired curve. Front and back faces will alternate and blocks trimmed as needed to provide a tight fit between blocks with no gaps on either side of the freestanding wall.

RETAINING WALL CORNERS

This page shows typical construction details for Belvedere 90° corners.

- Some basic concepts are shown here for 90° corners. Plan to take some time to properly work corners into the larger retaining and freestanding wall patterns.
- Walls are shown without batter for clarity. Blocks in a retaining wall should be adjusted slightly in place and trimmed as needed to allow wall construction with proper batter.

OUTSIDE CORNER

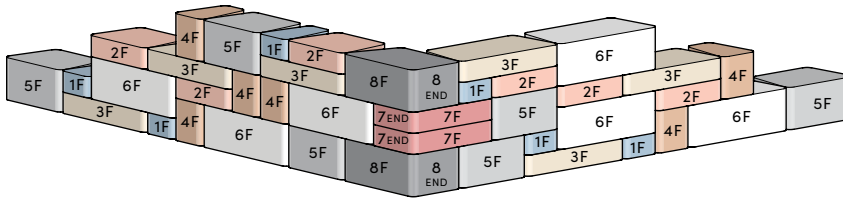

INSIDE CORNER

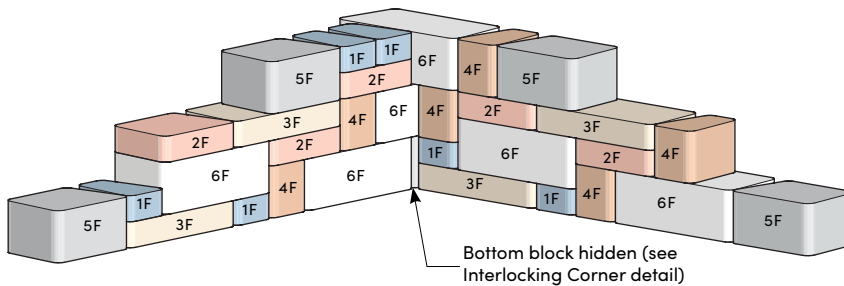

INTERLOCKING CORNER

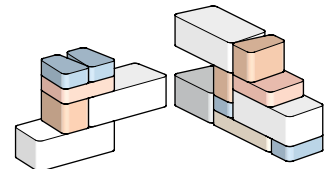

Place block in an overlapping, interlocking pattern at corner for added wall stability.

PILLARS

Pillars make nice ends to freestanding walls, formal stair openings, stand-alone monuments, and other areas to enhance your Belvedere project. The basic steps of pillar construction are shown here. Feel free to expand on these ideas and bring your own creativity into a custom project.

Step 1

Place (4) 3 in (76 mm) or 6 in (152 mm) high corner blocks with the taper facing into the center of the pillar.

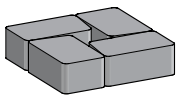

Step 2

Place the second row of (4) of the corner blocks with the taper facing into the center of the pillar. Typically if the first row is built with 6 in (152 mm) corner blocks, the second row is built with 3 in (76 mm) corner blocks.

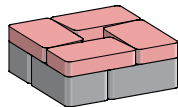

Step 3

Continue with subsequent rows to the desired pillar height. One pallet of corner blocks will make a 24 x 24 x 36 in (610 x 610 x 914 mm) high column.

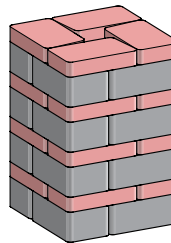

Step 4

Place a column cap to finish the pillar. The column cap can be cored as needed for installation of a light.

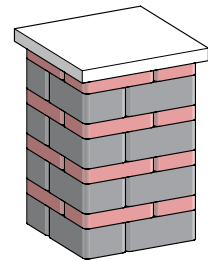

PILLARS WITH FREESTANDING WALL

Freestanding walls with pillars on each end can be constructed either with the pillars flush with the wall, or blocks trimmed to interlock the end of the wall with the pillar.

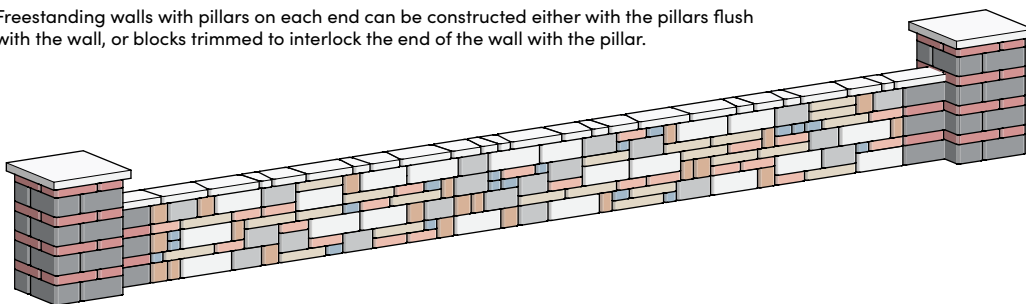

GENERAL NOTES FOR WALL SECTIONS

This page shows typical construction details for Belvedere walls. These drawings are representative of major components required in wall construction. Specific details including geotextile reinforcement layers, drainage details, soil requirements, etc. shall be per engineered design for the wall.

- These drawings are for preliminary reference only (not for final construction).
- Final designs for construction **must be prepared by a registered professional engineer** using the actual conditions of the proposed site and loads.
- Final wall design must address both internal and external drainage and shall be evaluated by the professional engineer who is responsible for the wall design.
- Block size and placement shown are for reference only, individual Belvedere blocks will vary with installation pattern.

TYPICAL FREESTANDING WALL DETAIL

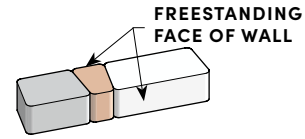
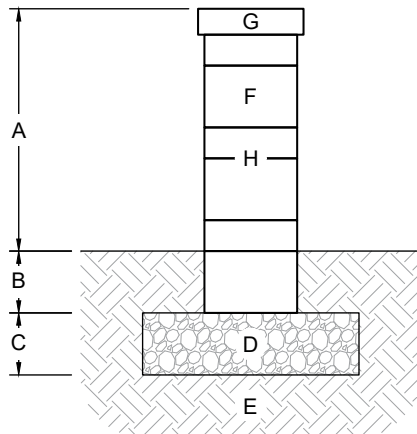

- A. Wall height above grade (max. 24 in (610 mm))
- B. Wall buried beneath grade (min. 6 in (152 mm))
- C. Leveling pad depth (min. 6 in (152 mm))
- D. Crushed stone leveling pad
- E. Foundation soil compacted to 95% max. dry density
- F. Wall blocks
- G. Cap block
- H. Concrete adhesive required between all blocks and caps

TYPICAL GRAVITY RETAINING WALL DETAIL

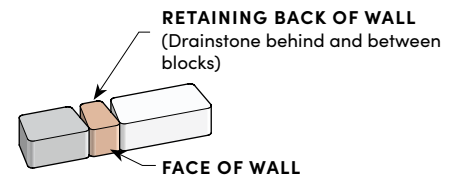
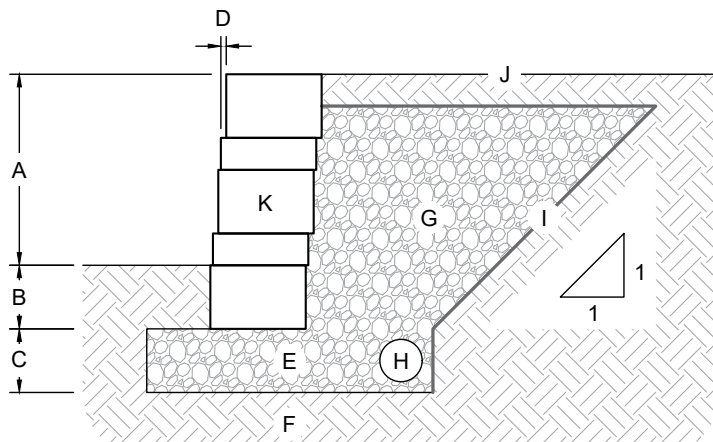

- A. Wall height above grade (varies)
- B. Wall buried beneath grade (min. 6 in (152 mm))
- C. Leveling pad depth (min. 6 in (152 mm))
- D. 1/2 in (13 mm) setback per 6 in (152 mm) course (5°)
- E. Crushed stone leveling pad
- F. Foundation soil compacted to 95% max. dry density
- G. Drainstone (ASTM #57 on 1:1 slope behind wall)
- H. 4 in corrugated perforated drain pipe
- I. Min. 3.5 oz. non-woven geotextile fabric
- J. Finish grade to drain away from the wall
- K. Wall blocks

TYPICAL REINFORCED RETAINING WALL DETAIL

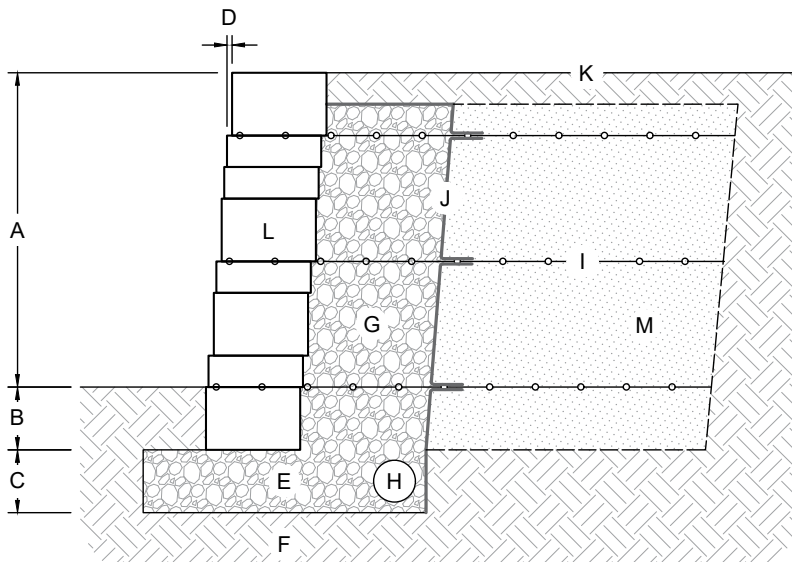

- A. Wall height above grade (varies by design)
- B. Wall buried beneath grade (varies by design)
- C. Leveling pad depth (varies by design)
- D. 1/2 in (13 mm) setback per 6 in (152 mm) course (5°)
- E. Crushed stone leveling pad
- F. Foundation soil compacted to 95% max. dry density
- G. Drainstone (ASTM #57, min. 12 in (305 mm) behind wall)
- H. 4 in (102 mm) corrugated perforated drain pipe
- I. Geogrid (lengths and vertical placement per design)
- J. Min. 3.5 oz. non-woven geotextile fabric
- K. Finish grade to drain away from the wall
- L. Wall blocks



KODAH

FEATURES

- Unique large scale with modern, linear proportions
- Multiple face textures for each block size creates a natural quarried and random look
- Retaining walls and double-sided freestanding walls possible with the wall block. Blocks are finished on both the front and back faces and are tapered on each side approximately 1.5 in (38 mm) from the front to the back of the block.
- Corner blocks can be used to construct columns, provide a finished end on a freestanding wall, and make 90° corners. Blocks are finished on three sides, and the fourth side is tapered to fit with the other wall blocks.

FOR PRELIMINARY WALL SECTIONS
SCAN HERE



Notes:

*Colors & product availability vary by region.

WALL PALLET



Weight:	±2,500 lb (±1,134 kg) (inc. pallet)
Coverage (Retaining):	21 sq ft (6.2 sq m)
Coverage (Freestanding):	20 sq ft (6.1 sq m)
Layers Per Pallet:	3
Section:	7 sq ft (2.1 sq m) per layer

NOTE: Dimensions are nominal due to texture



UNIT: 1	L x D x H +/-
Dimensions:	42 x 10.5 x 6 in (1067 x 267 x 152 mm)
Weight:	±200 lb (±91 kg)
Units Per Pallet:	6



UNIT: 2	L x D x H +/-
Dimensions:	30 x 10.5 x 6 in (762 x 267 x 152 mm)
Weight:	±140 lb (±64 kg)
Units Per Pallet:	3



UNIT: 3	L x D x H +/-
Dimensions:	21 x 10.5 x 6 in (533 x 267 x 152 mm)
Weight:	±100 lb (±45 kg)
Units Per Pallet:	6



UNIT: 4	L x D x H +/-
Dimensions:	12 x 10.5 x 6 in (305 x 267 x 152 mm)
Weight:	±50 lb (±23 kg)
Units Per Pallet:	3

CORNER PALLET



Weight:	±2,500 lb (±1,134 kg) (inc. pallet)
Coverage:	31.5 sq ft (9.6 sq m)
Layers Per Pallet:	3
Section:	1.3 sq ft (0.4 sq m) per piece



CORNER UNIT	L x D x H +/-
Dimensions:	21 x 10.5 x 6 in (533 x 267 x 152 mm)
Weight:	±100 lb (±45 kg)
Units Per Pallet:	24 (12 left, 12 right)

CURVES

This page shows typical construction details for making curved walls with Kodah blocks. The tapered sides of the blocks allow for construction of a wide range of curves in both retaining and freestanding walls. Walls are shown below without batter for clarity. Blocks in a retaining wall should be adjusted slightly in place and trimmed as needed to allow wall construction with proper batter.

- Minimum radius curves are shown which can be constructed without saw cutting a significant number of blocks. Larger radius curves can be created by leaving a larger gap between blocks on the back side of the wall. The gaps must be filled with drainstone.
- When retaining walls are constructed with batter, the radius on outside curves becomes smaller with each course due to the block setback. For proper construction, the radius of the bottom course must be larger than the minimum radius so upper courses will have sufficient room for construction.
- When retaining walls are constructed with a batter, the radius on inside curves becomes larger with each course due to the block setback.

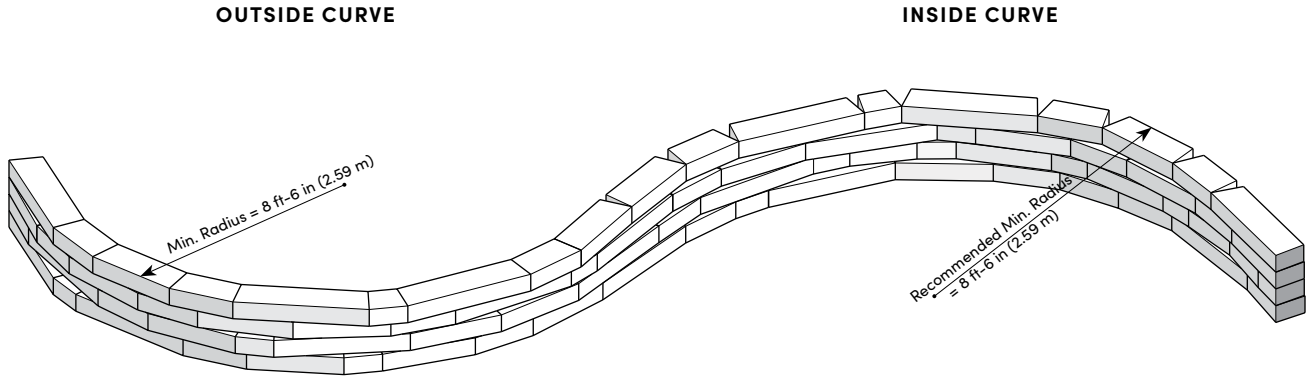

PILLARS

Kodah pillars can be constructed utilizing 1 full pallet of Kodah corner blocks. A 34 in (864 mm) column cap can be utilized to finish the pillar. The Column Cap can be cored as needed to accommodate the installation of a lamp.

Step 1

Place (4) Kodah corner blocks with the same taper, facing into the center of the pillar.

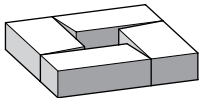

Step 2

Place a second row of (4) Kodah corner blocks with the opposite taper, facing into the center of the pillar.

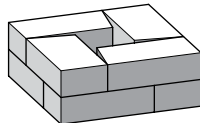

Step 3

Continue with subsequent rows to the desired pillar height. One pallet of corner blocks will create a 32 x 32 x 36 in (813 x 813 x 914 mm) tall column.

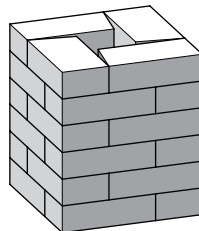

Step 4

Place a column cap to finish the pillar. The column cap can be cored as needed for installation of a lamp.

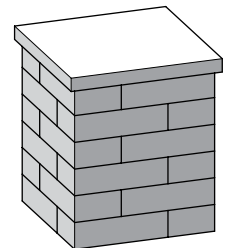

GENERAL NOTES FOR WALL SECTIONS

This page shows typical construction details for Kodah walls. These drawings are representative of major components required in wall construction. Specific details including geotextile reinforcement layers, drainage details, soil requirements, etc. shall be per engineered design for the wall.

- These drawings are for preliminary reference only (not for final construction).
- Final designs for construction must be prepared by a registered professional engineer using the actual conditions of the proposed site.
- Final wall design must address both internal and external drainage and shall be evaluated by the professional engineer who is responsible for the wall design.

TYPICAL FREESTANDING WALL DETAIL

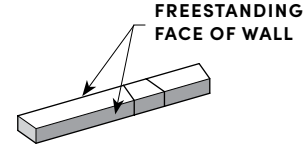
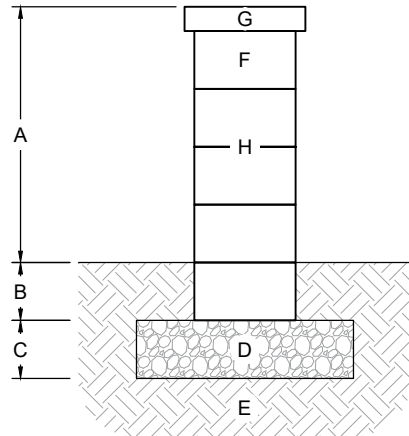

- A. Exposed height (varies, max. 24 in (610 mm))
- B. Bury depth (min. 6 in (152 mm))
- C. Leveling pad depth (min. 6 in (152 mm))
- D. Crushed stone leveling pad
- E. Foundation soil compacted to 95% max. dry density
- F. Wall blocks
- G. Coping block
- H. Heavy Duty Construction Adhesive or One-Component, High Performance, Elastomeric Polyurethane Sealant required between all blocks and caps

TYPICAL GRAVITY RETAINING WALL DETAIL

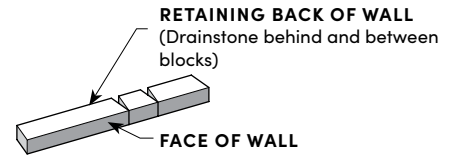
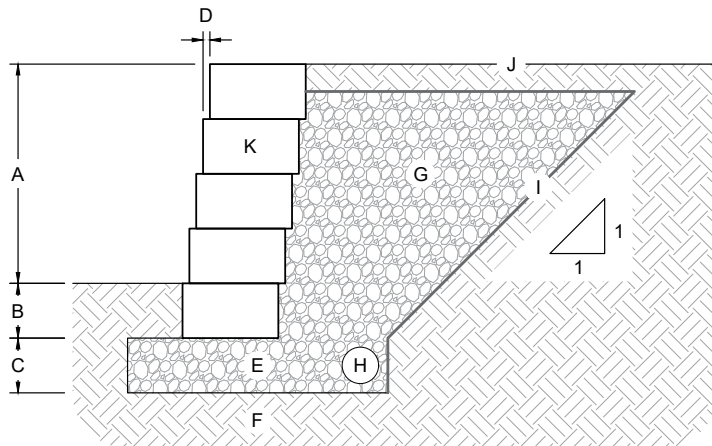

- A. Exposed height (varies by design), 2 ft (610 mm) max. height without reinforcement
- B. Bury depth (varies by design, min. 6 in (152 mm))
- C. Leveling pad depth (varies by design, min. 6 in (152 mm))
- D. Recommended horizontal setback, 3/4 in (19 mm) (7° batter angle on wall)
- E. Crushed stone leveling pad
- F. Foundation soil compacted to 95% max. dry density
- G. Drainstone (ASTM #57 on 1:1 slope behind wall)
- H. 4 in (102 mm) corrugated perforated drain pipe
- I. Non-woven geotextile fabric
- J. Finish grade to drain away from the wall
- K. Wall blocks

TYPICAL REINFORCED RETAINING WALL DETAIL

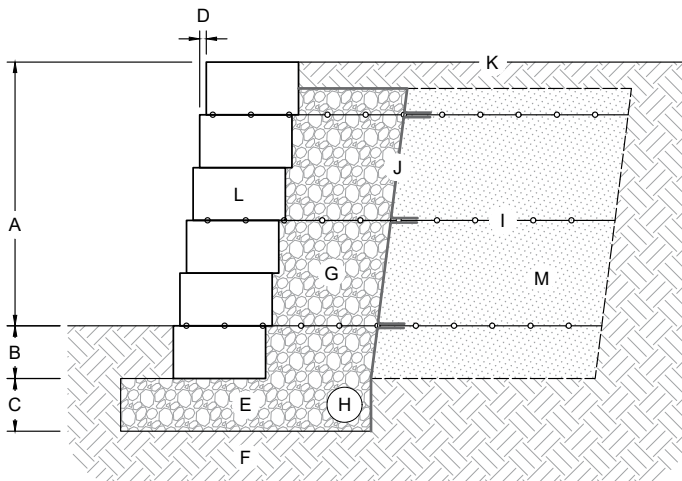

- A. Exposed height (varies by design)
- B. Bury depth (varies by design, min. 6 in (152 mm))
- C. Leveling pad depth (varies by design, min. 6 in (152 mm))
- D. Recommended horizontal setback, 3/4 in (19 mm) (7° batter angle on wall)
- E. Crushed stone leveling pad
- F. Foundation soil compacted to 95% max. dry density
- G. Drainstone (ASTM #57, min. 12 in (305 mm) behind wall)
- H. 4 in (102 mm) corrugated perforated drain pipe
- I. Geogrid reinforcement (lengths and vertical placement per design)
- J. Non-woven geotextile fabric
- K. Finish grade to drain away from the wall
- L. Wall blocks
- M. Reinforced soil compacted to 95% max. dry density

489

HEARTWOOD

FEATURES

- Genuine wood texture compliments a variety of applications
- More durable than pressure-treated lumber
- Quality materials = low maintenance alternative to wood
- Great for landscape applications like garden walls or window wells

Notes:

*Colors & product availability vary by region.

WALL PALLET



Weight: $\pm 2,600$ lb ($\pm 1,179$ kg) (inc. pallet)
Coverage: 26.25 sq ft (8 sq m)
Layers Per Pallet: 3

UNIT: 1	L x D x H
Dimensions:	6 x 8 x 42 in (152 x 203 x 1067 mm)
Weight:	± 171 lb (± 78 kg)
Units Per Pallet:	15

UNIT: 2	L x D x H
Dimensions:	6 x 8 x 21 in (152 x 203 x 533 mm)
Weight:	± 85 lb (± 39 kg)
Units Per Pallet:	30

GENERAL NOTES FOR WALL SECTIONS

This page shows typical construction details for Heartwood walls. These drawings are representative of major components required in wall construction. Specific details including geotextile reinforcement layers, drainage details, soil requirements, etc. shall be per engineered design for the wall.

- These drawings are for preliminary reference only (not for final construction).
- Final designs for construction must be prepared by a registered professional engineer using the actual conditions of the proposed site.
- Final wall design must address both internal and external drainage and shall be evaluated by the professional engineer who is responsible for the wall design.

TYPICAL FREESTANDING WALL DETAIL

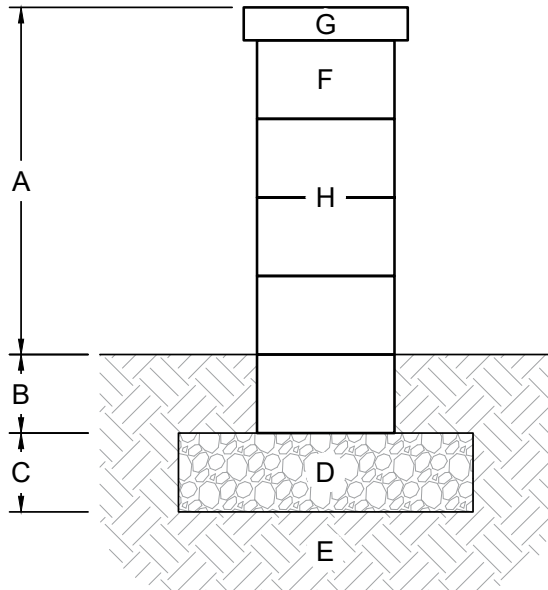

- A. Exposed height (varies, max. 24 in (610 mm))
- B. Bury depth (min. 6 in (152 mm))
- C. Leveling pad depth (min. 6 in (152 mm))
- D. Crushed stone leveling pad
- E. Foundation soil compacted to 95% max. dry density
- F. Wall blocks
- G. Coping block
- H. Heavy Duty Construction Adhesive or One-Component, High Performance, Elastomeric Polyurethane Sealant required between all blocks and caps

TYPICAL GRAVITY RETAINING WALL DETAIL

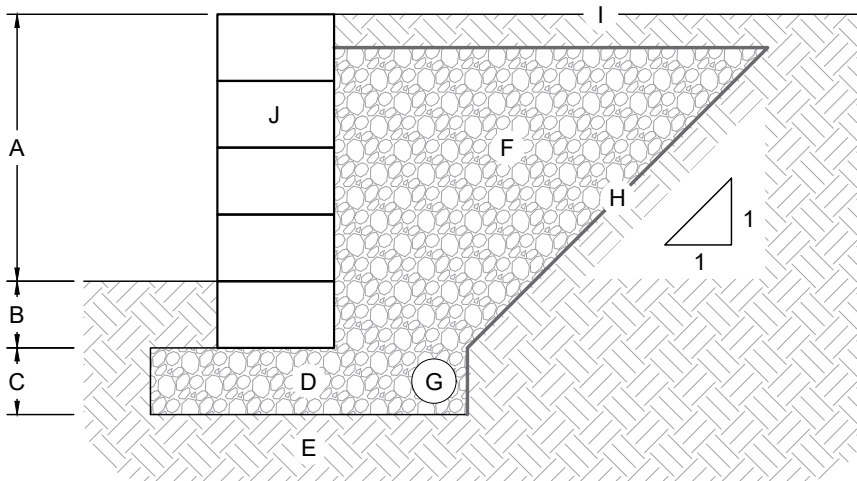

- A. Exposed height (varies by design), 2 ft (610 mm) max. height without reinforcement
- B. Bury depth (varies by design, min. 6 in (152 mm))
- C. Leveling pad depth (varies by design, min. 6 in (152 mm))
- D. Crushed stone leveling pad
- E. Foundation soil compacted to 95% max. dry density
- F. Drainstone (ASTM #57 on 1:1 slope behind wall)
- G. 4 in (102 mm) corrugated perforated drain pipe
- H. Non-woven geotextile fabric
- I. Finish grade to drain away from the wall
- J. Wall blocks

CLAREMONT

FEATURES

- Linear, horizontal proportions evoke a contemporary yet classic stone appearance
- Each unit is finished on both the front and back surfaces, allowing for both freestanding and retaining walls
- Crisp and chiseled stone texture is indistinguishable from natural snapped limestone drywall
- One corner pallet contains enough corners to build a 30 x 30 in (762 x 762 mm) pillar, 40 in (1016 mm) tall
- Pillar caps sold separately

Notes:

*Colors & product availability vary by region.

WALL PALLET



Weight: ±2,800 lb (±1,270 kg) (inc. pallet)
 Coverage: 29 sq ft (8.8 sq m)
 Layers Per Pallet: 5
 Section: 1.16 sq ft (0.4 sq m) (1 ea 18 in (457 mm) and 1 ea 24 in (610 mm))

UNIT: 18 in (457 mm)

Dimensions: 18 x 8 x 4 in (457 x 203 x 102 mm)
 Weight: ±43 lb (±20 kg)
 Units Per Pallet: 25

UNIT: 24 in (610 mm)

Dimensions: 24 x 8 x 4 in (610 x 203 x 102 mm)
 Weight: ±61 lb (±28 kg)
 Units Per Pallet: 25

CORNER PALLET



Weight: ±2,200 lb (±998 kg) (inc. pallet)
 Coverage: 33.3 sq ft (10.1 sq m)
 Layers Per Pallet: 4
 Section: .83 sq ft (0.25 sq m) equals 1 piece (section sold by the piece)

UNIT: CORNER L x D x H

Dimensions: 22 x 8 x 4 in (559 x 203 x 102 mm)
 Weight: ±53 lb (±24 kg)
 Units Per Pallet: 40

CLAREMONT

CURVES

The minimum radius without cutting is 28 ft (8.53 m) to the outside of the curve. Wall aesthetics can be improved by using a radius larger than the minimum required.

OUTSIDE CURVE

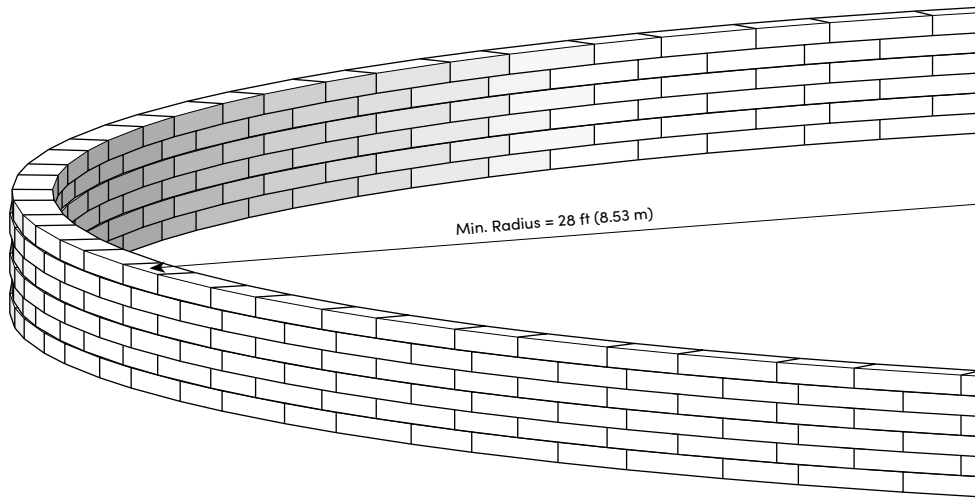

PILLARS

Pillars make nice ends to freestanding walls, formal stair openings, stand-alone monuments, and other areas to enhance your Claremont project. The basic steps of pillar construction are shown here. Feel free to expand on these ideas and bring your own imagination into creating a custom project.

Step 1

Place (4) Claremont corner blocks with the texture facing outward.

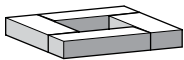

Step 2

Place a second row of (4) Claremont corner blocks with the texture facing outward.

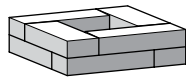

Step 3

Continue with subsequent rows to the desired pillar height. One pallet of corner blocks will create a 30 x 30 x 40 in (762 x 762 x 1016 mm) tall column.

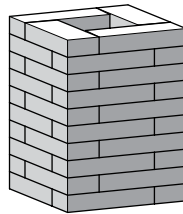

Step 4

Place a column cap to finish the pillar. The column cap can be cored as needed for installation of a light.

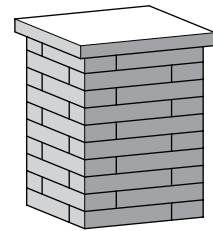

GENERAL NOTES FOR WALL SECTIONS

This page shows typical construction details for Claremont walls. These drawings are representative of major components required in wall construction. Specific details including geotextile reinforcement layers, drainage details, soil requirements, etc. shall be per engineered design for the wall.

- These drawings are for preliminary reference only (not for final construction).
- Final designs for construction must be prepared by a registered professional engineer using the actual conditions of the proposed site and loads.
- Final wall design must address both internal and external drainage and shall be evaluated by the professional engineer who is responsible for the wall design.

TYPICAL FREESTANDING WALL DETAIL

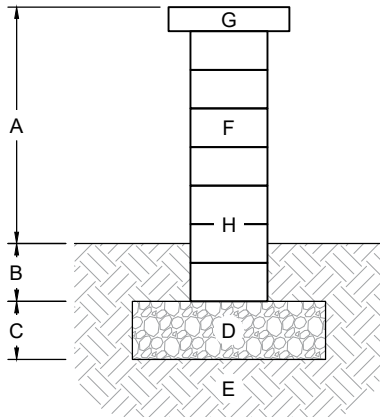

- A. Wall height above grade (max. 24 in (610 mm))
- B. Wall buried beneath grade (min. 6 in (152 mm))
- C. Leveling pad depth (min. 6 in (152 mm))
- D. Crushed stone leveling pad
- E. Foundation soil compacted to 95% max. dry density
- F. Wall blocks
- G. Cap block
- H. Heavy Duty Construction Adhesive or One-Component, High Performance, Elastomeric Polyurethane Sealant required between all blocks and caps

TYPICAL GRAVITY RETAINING WALL DETAIL

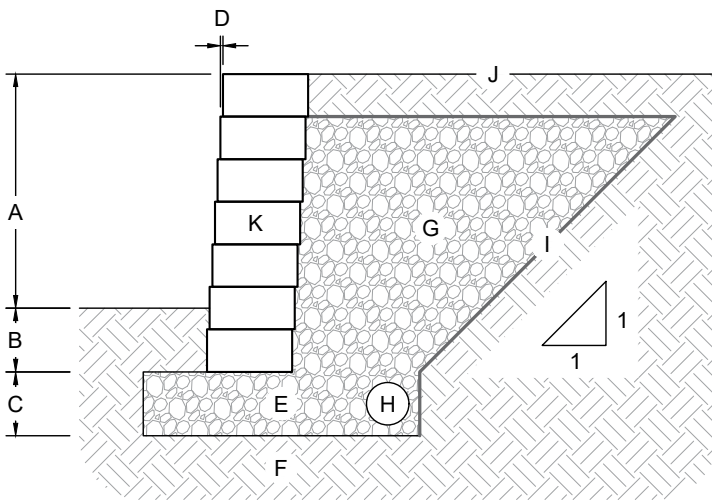

- A. Exposed height (varies by design), 2 ft (610 mm) max. height without reinforcement
- B. Bury depth (varies by design, min. 6 in (152 mm))
- C. Leveling pad depth (varies by design, min. 6 in (152 mm))
- D. Recommended horizontal setback, 1/4 in (6 mm) (4° batter angle on wall)
- E. Crushed stone leveling pad
- F. Foundation soil compacted to 95% max. dry density
- G. Drainstone (ASTM #57 on 1:1 slope behind wall)
- H. 4 in (102 mm) corrugated perforated drain pipe
- I. Non-woven geotextile fabric
- J. Finish grade to drain away from the wall
- K. Wall blocks

TYPICAL REINFORCED RETAINING WALL DETAIL

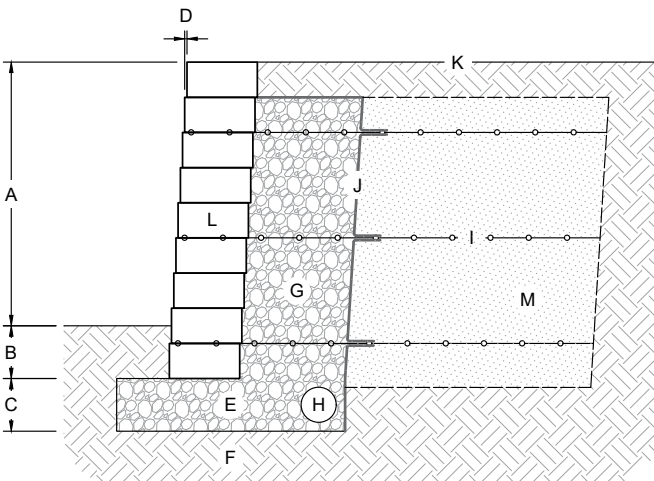

- A. Exposed height (varies by design)
- B. Bury depth (varies by design, min. 6 in (152 mm))
- C. Leveling pad depth (varies by design, min. 6 in (152 mm))
- D. Recommended horizontal setback, 1/4 in (6 mm) (4° batter angle on wall)
- E. Crushed stone leveling pad
- F. Foundation soil compacted to 95% max. dry density
- G. Drainstone (ASTM #57, min. 12 in (305 mm) behind wall)
- H. 4 in (102 mm) corrugated perforated drain pipe
- I. Geogrid reinforcement (lengths and vertical placement per design)
- J. Non-woven geotextile fabric
- K. Finish grade to drain away from the wall
- L. Wall blocks
- M. Reinforced soil compacted to 95% max. dry density



DIMENSIONAL

FEATURES

- Perfect for small garden and freestanding walls, custom bar and grill units, edging, columns and more
- Small and lightweight units for easy stacking
- Natural stone texture on four sides
- Wedge units for curved walls and edging

Notes:

*Colors & product availability vary by region.

STRAIGHT PALLET



Weight: ±2,100 lb (±953 kg) (inc. pallet)
 Coverage (Retaining): 25 sq ft (7.6 sq m)
 Coverage (Freestanding): 25 sq ft (7.6 sq m)
 Layers Per Pallet: 5
 Section: sold by the piece



UNIT: STRAIGHT	L x D x H
Dimensions:	12 x 8 x 4 in (305 x 203 x 102 mm)
Weight:	±28 lb (±13 kg)
Units Per Pallet:	75

WEDGE PALLET



Weight: ±2,000 lb (±907 kg) (inc. pallet)
 Coverage (Retaining): 33.3 sq ft (10.1 sq m)
 Coverage (Freestanding): 27 sq ft (8.2 sq m)
 Layers Per Pallet: 5
 Section: sold by the piece



UNIT: WEDGE	L x D x H
Dimensions (Front):	12 x 8 x 4 in (305 x 203 x 102 mm)
Dimensions (Back):	7.5 x 8 x 4 in (191 x 203 x 102 mm)
Weight:	±20 lb (±9 kg)
Units Per Pallet:	100

Actual weight and volumes may vary. Weight shown is based on concrete.

CURVES

The minimum radius using the wedge block without cutting is 2 ft (0.6 m). Wall aesthetics can be improved by using a radius larger than the minimum required.

2 ft-0 in (0.6 m-0 mm) Radius
(Wedge Blocks)

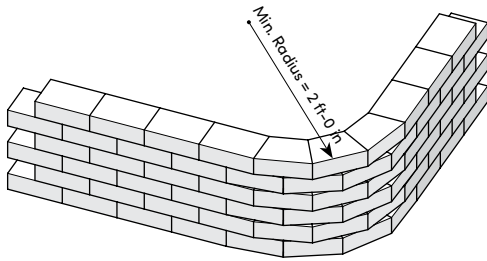

3 ft-0 in (0.9 m-0 mm) Radius
(2:1 Wedge to Straight Blocks)

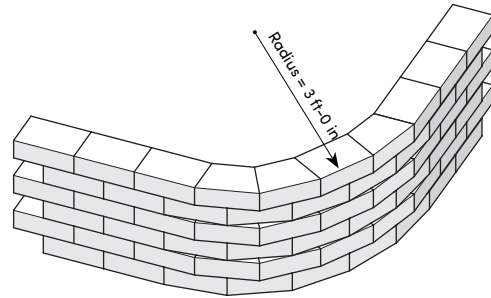

4 ft-0 in (1.2 m-0 mm) Radius
(1:1 Wedge to Straight Blocks)

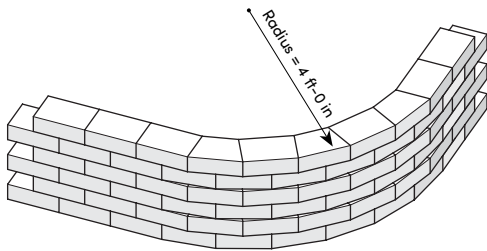

6 ft-0 in (1.8 m-0 mm) Radius
(2:1 Straight to Wedge Blocks)

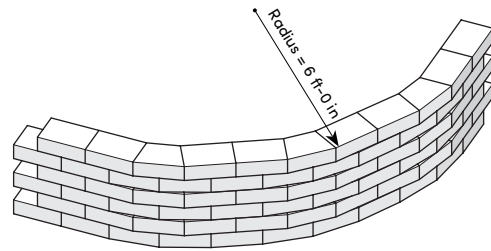

PILLARS

Pillars make wall ends to freestanding walls, formal stair openings, stand-alone monuments, and other areas to enhance your Dimensional project. The basic steps of pillar construction are shown here. Feel free to expand on these ideas and bring your own imagination into creating a custom project.

Step 1

Place (4) Dimensional blocks.

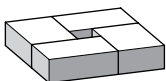

Step 2

Place a second row of (4) Dimensional blocks.

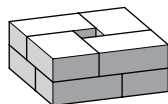

Step 3

Continue with subsequent rows to the desired pillar height. One pallet of corner blocks will create two 20 x 20 x 36 in (508 x 508 x 914 mm) tall column.

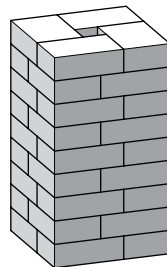

Step 4

Place a column cap to finish the pillar. The column cap can be cored as needed for installation of a light.

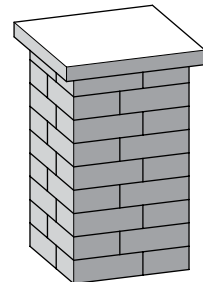

GENERAL NOTES FOR WALL SECTIONS

This page shows typical construction details for Dimensional walls. These drawings are representative of major components required in wall construction. Specific details including geotextile reinforcement layers, drainage details, soil requirements, etc. shall be per engineered design for wall.

- These drawings are for preliminary reference only (not for final construction).
- Final designs for construction must be prepared by a registered professional engineer using the actual conditions of the proposed site and loads.
- Final wall design must address both internal and external drainage and shall be evaluated by the professional engineer who is responsible for the wall design.

TYPICAL FREESTANDING WALL DETAIL

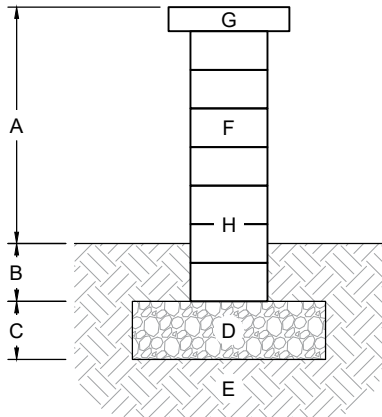

- A. Exposed height (varies, max. 24 in (610 mm))
- B. Bury depth (min. 6 in (152 mm))
- C. Leveling pad depth (min. 6 in (152 mm))
- D. Crushed stone leveling pad
- E. Foundation soil compacted to 95% max. dry density
- F. Wall blocks
- G. Coping block
- H. Heavy Duty Construction Adhesive or One-Component, High Performance, Elastomeric Polyurethane Sealant required between all blocks and caps

TYPICAL GRAVITY RETAINING WALL DETAIL

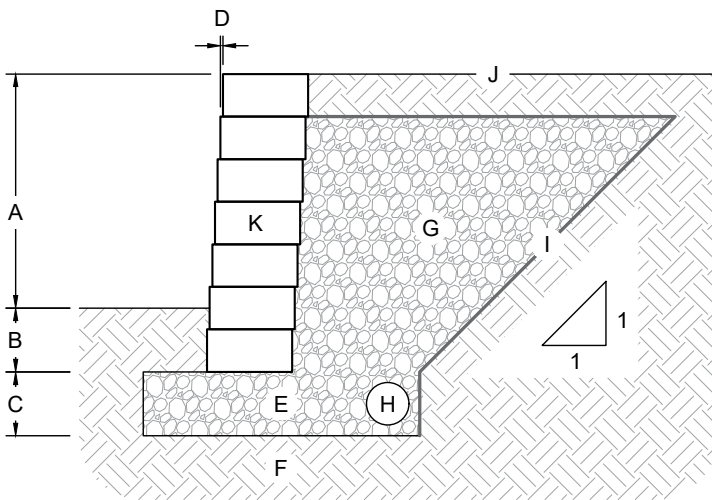

- A. Exposed height (varies by design), 2 ft (610 mm) max. height without reinforcement
- B. Bury depth (varies by design, min. 6 in (152 mm))
- C. Leveling pad depth (varies by design, min. 6 in (152 mm))
- D. Recommended horizontal setback, 1/4 in (6 mm) (4° batter angle on wall)
- E. Crushed stone leveling pad
- F. Foundation soil compacted to 95% max. dry density
- G. Drainstone (ASTM #57 on 1:1 slope behind wall)
- H. 4 in (102 mm) corrugated perforated drain pipe
- I. Non-woven geotextile fabric
- J. Finish grade to drain away from the wall
- K. Wall blocks

TYPICAL REINFORCED RETAINING WALL DETAIL

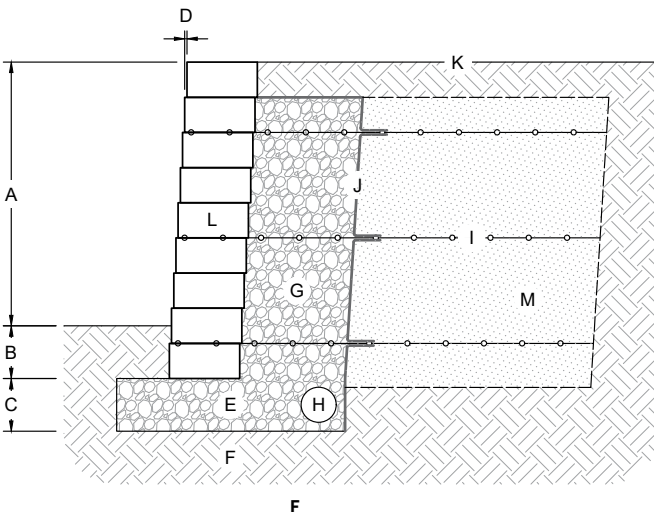

- A. Exposed height (varies by design)
- B. Bury depth (varies by design, min. 6 in (152 mm))
- C. Leveling pad depth (varies by design, min. 6 in (152 mm))
- D. Recommended horizontal setback, 1/4 in (6 mm) (4° batter angle on wall)
- E. Crushed stone leveling pad
- F. Foundation soil compacted to 95% max. dry density
- G. Drainstone (ASTM #57, min. 12 in (305 mm) behind wall)
- H. 4 in (102 mm) corrugated perforated drain pipe
- I. Geogrid reinforcement (lengths and vertical placement per design)
- J. Non-woven geotextile fabric
- K. Finish grade to drain away from the wall
- L. Wall blocks
- M. Reinforced soil compacted to 95% max. dry density

SLABS & PAVERS

GENERAL INFORMATION

GRAND FLAGSTONE

DIMENSIONAL FLAGSTONE

LINEAR FLAGSTONE

24 X 24 FLAGSTONE

MIROS

NEW MISSION

OLD MISSION

AMARO

BORDO

SUPERIOR STEPPERS



BASIC SLAB & PAVER INSTALLATION NOTES FOR:

- Grand Flagstone
- Dimensional Flagstone
- 24 x 24 Flagstone
- Miros
- New Mission
- Old Mission
- Amaro
- Bordo
- Superior Steppers

Refer to product pages for specific information and details pertaining to individual products.

Thank you for your interest in installing our paving products. You will find that these products truly combine the look of natural stone with the efficiency and consistency of concrete pavers.

SAFETY

Make safety your top priority when installing our paving products. Before starting your project, be sure to address the following points:

Contact your local utility marking service prior to making any excavation. Be sure to follow all governmental safety regulations.

Always wear the appropriate personal protective equipment (PPE) including gloves, steel toed boots, safety glasses, hearing protection, respiratory protection, and any other needed safety gear.

Flagstone and Miros slabs are heavy. Utilize mechanical installation when possible. Follow proper lifting techniques to avoid back injury. Also, use two people to set larger pieces.

PROJECT PLANNING

The first step in installing our paving products is to plan your project. Paver layout and placement is important to insure a functional and good looking installation. Remember, Flagstone products are suitable for pedestrian loading only (patios, walkways, etc.) and will not support the load of a vehicle. Mission and Amaro Pavers are suitable for vehicular loading.

FOR THE MOST NATURAL APPEARANCE, MIX AND INSTALL PRODUCTS FROM MULTIPLE PALLETS SIMULTANEOUSLY. THIS WILL CREATE A MORE BLENDED, NATURAL LOOK.

EXCAVATION AND BASE PREPARATION

Once you are ready to start construction, you will need to lay out the project area. Mark out the area of the installation with marking paint. Mark a second line 12 in (305 mm) outside of the first line that indicates the area to be excavated. This over-excavation will allow for proper base installation.

Excavate to the required depth and grade for the installation of the specific paving product you are installing (see cross sections for minimum recommended excavation depths). Once the excavation depth has been established, compact the sub-grade well using a vibratory plate compactor. At this point, Rosetta Hardscapes recommends laying a woven geotextile down before applying any granular base materials.

PERMEABLE INSTALLATIONS: Unless specified, avoid compaction of existing sub-grade soils if installing a permeable pavement.

PLACE THE COMPACTED GRAVEL BASE

For standard paver and flagstone installations, begin by spreading half of granular base material in the excavation. **(Note: Lifts should not exceed 6 in (150 mm) in thickness.)** Compact this first lift to 98% standard proctor using a vibratory plate compactor and adding water as needed. Add the second lift of granular material and compact in the same manner as the first. For permeable paver installations, install open-graded sub-base and base course material as specified in the project drawings.

KEY POINT: When installing granular base materials, be sure to consider proper grades to prevent water from standing on the surface and make sure water is directed away from building structures.

PAVER INSTALLATION

Bedding material requirements and paver installation vary by product type. Please see the following product specific installation instructions and tips for more details on paver installation.

ADDITIONAL INSTALLATION NOTES FOR:

- New Mission
- Old Mission
- Amaro

Refer to product pages for specific information and details pertaining to individual products.

FOR THE MOST NATURAL APPEARANCE, MIX AND INSTALL PRODUCTS FROM MULTIPLE PALLETS SIMULTANEOUSLY. THIS WILL CREATE A MORE BLENDED, NATURAL LOOK.

INSTALLATION NOTES

The following guidelines are based on minimum recommendations from the ICPI (Interlocking Concrete Pavement Institute). For an in-depth overview of the design and installation of interlocking concrete pavements and permeable pavements, please visit their website at icpi.org. Paver cross-sections and details shown are based on pedestrian or residential drive loadings with normal site conditions. Foundation, gravel base, and drainage details will need to be addressed if poor soil conditions or commercial or industrial vehicular loadings will be present.

EDGE RESTRAINT

Before installing pavers or bedding material, ensure proper paver edge restraint has been installed. Edge restraint should consist of a precast or cast-in-place concrete curb. For pedestrian loads or residential drives, plastic or metal edging strips fastened to the compacted base below with metal spikes are an acceptable alternative.

BEDDING MATERIAL

For standard paver installation (non-permeable applications), apply bedding sand at a maximum thickness of 1 in (25mm) on top of the compacted granular base. Level bedding sand evenly by using a screed board along the top of the screed rails. Do not bed pavers in sand for permeable paver installations. Instead, bed pavers in 2 in (50 mm) of ASTM #8 aggregate.

PAVER INSTALLATION

Begin by laying the individual pavers on screeded bedding material according to your detailed project plan.

- Push pavers together so the spacer bars butt tight and cut units as needed to finish edges.
- To ensure proper color distribution, mix layers from several bundles at one time.
- Once installed, set pavers in bedding material by compacting with a plate compactor equipped with a urethane pad (to avoid damage to the paver surface). Compaction should proceed in overlapping rows such that each area is crossed at least twice by the compactor in two perpendicular directions. Note that pavements should be filled and compacted to within 6 ft (1.8 m) of the laying surface at the end of each work day.
- KEY POINT: Pavers will settle slightly (1/4 in - 3/8 in) (6.4 - 9.5 mm) during compaction. Final grade of base and bedding material should be adjusted to account for this settlement. Take special care where pavers abut existing site features such as other pavements.

CAUTION: A urethane pad must be used with the plate compactor to avoid damage to pavers.

JOINT SAND

Fill all joints with jointing sand for standard paver installations or appropriate aggregate for permeable installations. Sweep joint filler material into the joints between pavers until the joints are completely filled. After the joints are filled, carefully sweep pavers clean before compacting. Loose joint material could damage the surface of the pavers during compaction. Top off joints if joint material settles during compaction and re-compact if necessary.

OTHER CONSIDERATIONS

You may want to apply a sealer to protect the pavers from spills and stains. Always use a high quality sealer specifically formulated for wet-cast concrete.

When snowplowing Mission and Amaro Pavers, a poly cutting edge must be used to avoid marking the surface of the pavers.

Do not use de-icing salts on Mission and Amaro Pavers. Use of de-icing salts can damage the surface.



GRAND FLAGSTONE

FEATURES

- 15 unique shapes replicate large, irregular flagstone with natural stone texture
- Fast installations with easy-to-install pattern
- Uniform thickness to create comfortable end result
- High strength concrete means long term durability
- Multiple natural color blends available

Notes:

*Colors & product availability vary by region.

PALLET



Dimensions: 42 x 42 x 24 in (1067 x 1067 x 610 mm)
 Weight: ±2,000 lb (±907 kg) (inc. pallet)
 Coverage: 90 sq ft (27.4 sq m) (assumes 3/8 in (10 mm) joint)
 Layers Per Pallet: 8 (random assortment of layers)



LAYER: 1 L x W x H
 Dimensions: 42 x 38 x 1.75 in (1067 x 965 x 44.5 mm)
 Weight: ±245 lb (±111 kg)



LAYER: 2
 Dimensions: 42 x 38 x 1.75 in (1067 x 965 x 44.5 mm)
 Weight: ±245 lb (111± kg)



LAYER: 3
 Dimensions: 42 x 38 x 1.75 in (1067 x 965 x 44.5 mm)
 Weight: ±245 lb (±111 kg)



LAYER: 4
 Dimensions: 42 x 38 x 1.75 in (1067 x 965 x 44.5 mm)
 Weight: ±245 lb (±111 kg)

GRAND FLAGSTONE

INTERLOCKING LAYERS

COMMON POINTS

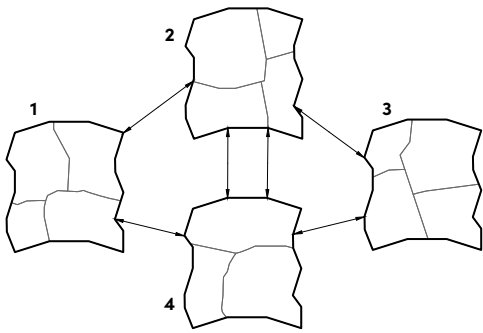

PROPER PLACEMENT

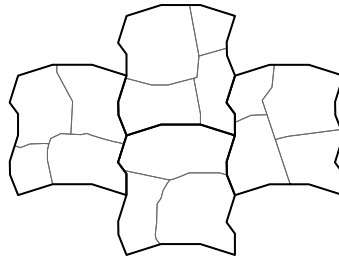

Note: Outside dimensions of each layer are identical to all other layers, allowing any layer to be substituted anywhere in the pattern.

± 3/8 in (± 10 mm) joints (typical)

PATTERNS

PATIO

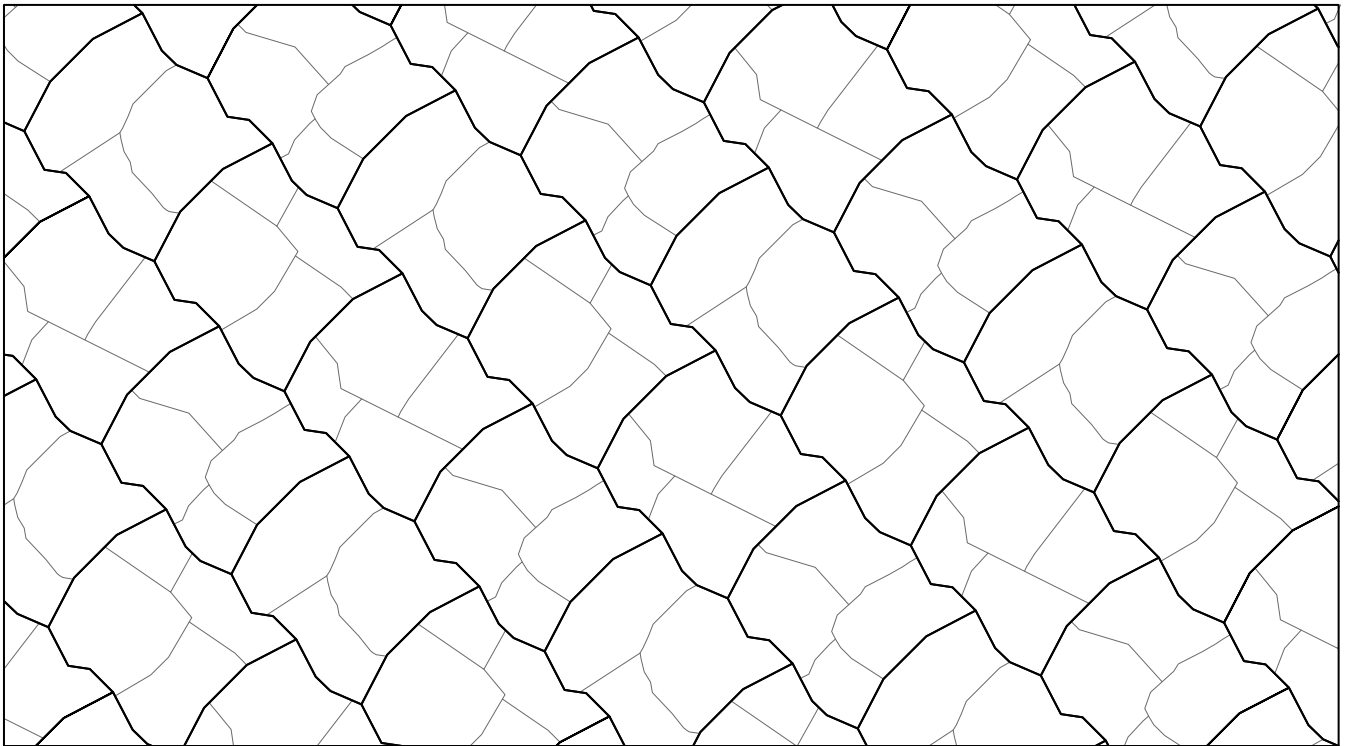

WALKWAY

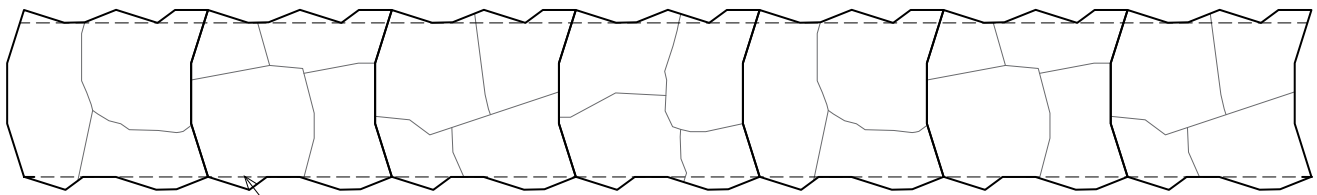

Leave jagged edge or trim to provide smooth edge (optional)

LAYOUT ORIENTATION

INCORRECT

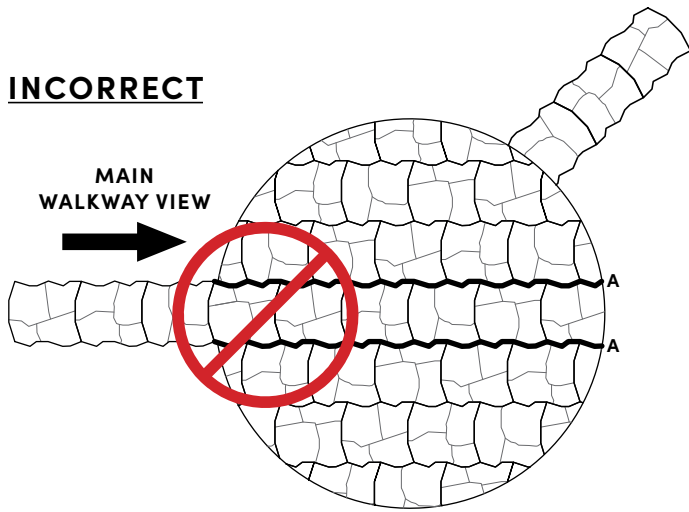

Layout orientation is important with Grand Flagstone. Due to the nature of the interlocking sets of slabs, there are long, unbroken joints between rows. Often, the irregular nature of the Grand Flagstone limits how noticeable these unbroken joints are in the finished project. However, the lines become slightly more noticeable when you are looking parallel to the unbroken joints than when you are looking at them on an angle. To limit this effect, Grand Flagstone layers should be laid at a 45° angle from the most common viewing angle. This viewing angle would most likely be a patio entrance or step location.

A. Long, unbroken lines caused by seam between layers

CORRECT

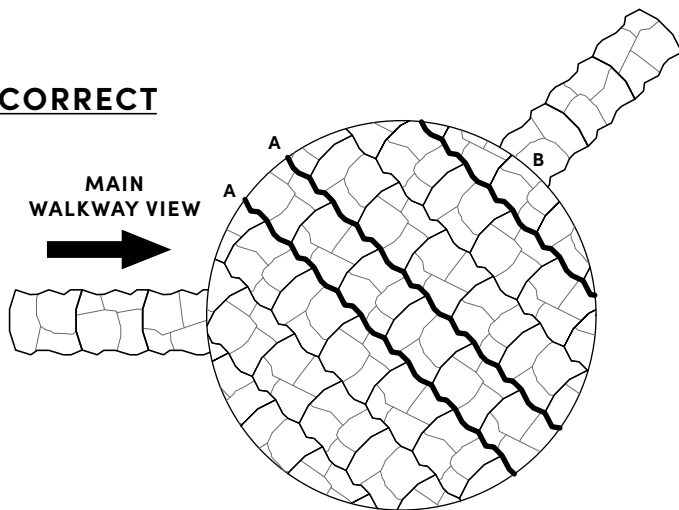

A. Long, unbroken lines caused by seam between layers oriented at 45° angle from main view

B. Long, unbroken lines caused by seam between layers oriented as close to 45° angle from secondary view as possible.

PROCEDURE FOR INSTALLING CRACKED PIECES



Individual pieces of Grand Flagstone can crack either during delivery to the job or during on-site handling prior to placement. Typically less than 5% of the pieces will crack. There are two methods to deal with cracked pieces.

The first method is to use the cracked pieces to fill in around the perimeter of the project where there is always a need for small pieces.

The second method is to use the cracked pieces to enhance the layout pattern. Since Grand Flagstone is designed to create an irregular flagstone walking surface, an extra crack simply provides another joint line in the Grand Flagstone pattern. Place the cracked pieces next to each other with a 3/8 in (10 mm) joint between them. The joint is filled with polymeric jointing sand just like all the other joints. If necessary, the cracked pieces may need to be trimmed to create a smoother edge or provide a larger joint to match all the other joints in your project.

- Trim broken edges if needed
- Install pieces with typical 3/8 in (10 mm) joint

INSTALLATION GUIDE

BEDDING SAND INSTALLATION

Using screed rails on the compacted granular base, apply bedding sand at a maximum thickness of 1 in (25 mm). By using a screed board along the top of the screed rails, the bedding sand will level evenly. Bedding sand should be compacted since Grand Flagstone slabs should not be compacted after installation.

FLAGSTONE INSTALLATION

- Begin by laying the individual pieces of Grand Flagstone on the screeded bedding material according to your detailed project plan.
- Separate individual pieces approximately 3/8 in (10 mm) from each other. When units are set with a 3/8 in (10 mm) gap, a full pallet will produce 90 sq ft (8.36 sq m) of coverage.
- Cut units as needed to finish edges.
- **Note:** To ensure proper color distribution, mix layers from several bundles at one time.

JOINT SAND INSTALLATION

Once the flagstone pieces are installed, fill all joints with jointing sand suitable for large joints. Sweep the sand into the joints between flagstones until the joints are completely filled. Follow the jointing sand manufacturer's recommendations for wetting the sand. You may need to repeat this process with more dry sand in a few days to completely fill the joints between individual slabs.

CAUTION: Grand Flagstone slabs should not be compacted after installation.

INTERLOCKING LAYERS

Grand Flagstone has been designed so each layer of slabs on a pallet is an interlocking set. Each interlocking set, or layer, of slabs has been designed to interlock with all other layers.

OTHER CONSIDERATIONS

You may want to apply a sealer to protect the flagstone slabs from spills and stains. Always use a high quality sealer specifically formulated for wet-cast concrete.

Not suitable for vehicular traffic

GENERAL NOTES FOR DETAILS

This page shows a typical detail for Grand Flagstone.

- This drawing is for preliminary reference only (not for final construction).
- **Final designs for construction must be prepared by a registered professional engineer using the actual conditions of the proposed site and loads.**
- Block size and placement shown are for reference only, individual blocks vary with installation pattern.
- Section shown is the minimum recommendation for pedestrian loading. Projects with heavier traffic or sites with poor soil conditions may require thicker gravel base, concrete curb edge restraint, and/or sand subbase.
- Provide adequate surface drainage to prevent ponded water.

TYPICAL RESIDENTIAL INSTALLATION

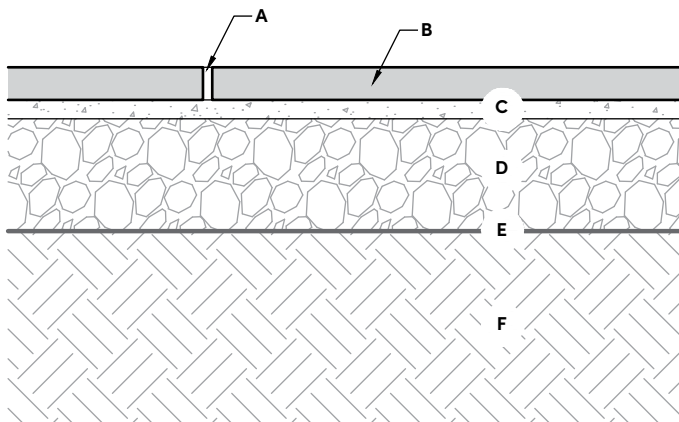

- A. Polymeric jointing sand between slabs (3/8 in (9.5 mm) thick)
- B. Grand Flagstone Slabs (1.75 in (45 mm) thick)
- C. Coarse bedding sand (1 in (25 mm) thick)
- D. Compacted gravel base (6 in (150 mm) thick)
- E. Woven geotextile (optional)
- F. Suitable, compacted subgrade

DIMENSIONAL FLAGSTONE

FEATURES

- Six unique shapes with 24 unique stone textures
- Uniform thickness and accurate dimensions translates into fast installation and a beautiful end result

Notes:

*Colors & product availability vary by region.

PALLET



Weight: ±2,350 lb (±1,066 kg) (inc. pallet)
 Coverage: 98 sq ft (29.3 sq m)
 Layers Per Pallet: 8
 Section: 12.25 sq ft (3.7 sq m) per layer

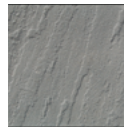

UNIT: 24 x 24 in (610 x 610 mm)

Dimensions: 24 x 24 x 2 in (610 x 610 x 51 mm)
 Weight: ±96 lb (±44 kg)
 Coverage: 4 sq ft (1.2 sq m)
 Units Per Pallet: 8



UNIT: 24 x 18 in (610 x 457 mm)

Dimensions: 24 x 18 x 2 in (610 x 457 x 51 mm)
 Weight: ±72 lb (±33 kg)
 Coverage: 3 sq ft (0.9 sq m)
 Units Per Pallet: 8



UNIT: 18 x 18 in (457 x 457 mm)

Dimensions: 18 x 18 x 2 in (457 x 457 x 51 mm)
 Weight: ±54 lb (±25 kg)
 Coverage: 2.25 sq ft (0.7 sq m)
 Units Per Pallet: 8



UNIT: 18 x 12 in (457 x 305 mm)

Dimensions: 18 x 12 x 2 in (457 x 305 x 51 mm)
 Weight: ±36 lb (±16 kg)
 Coverage: 1.5 sq ft (0.5 sq m)
 Units Per Pallet: 8



UNIT: 12 x 12 in (305 x 305 mm)

Dimensions: 12 x 12 x 2 in (305 x 305 x 51 mm)
 Weight: ±24 lb (±11 kg)
 Coverage: 1 sq ft (0.3 sq m)
 Units Per Pallet: 8



UNIT: 12 x 6 in (305 x 152 mm)

Dimensions: 12 x 6 x 2 in (305 x 152 x 51 mm)
 Weight: ±12 lb (±5 kg)
 Coverage: .5 sq ft (0.2 sq m)
 Units Per Pallet: 8

DIMENSIONAL FLAGSTONE

PATTERNS

PATIO

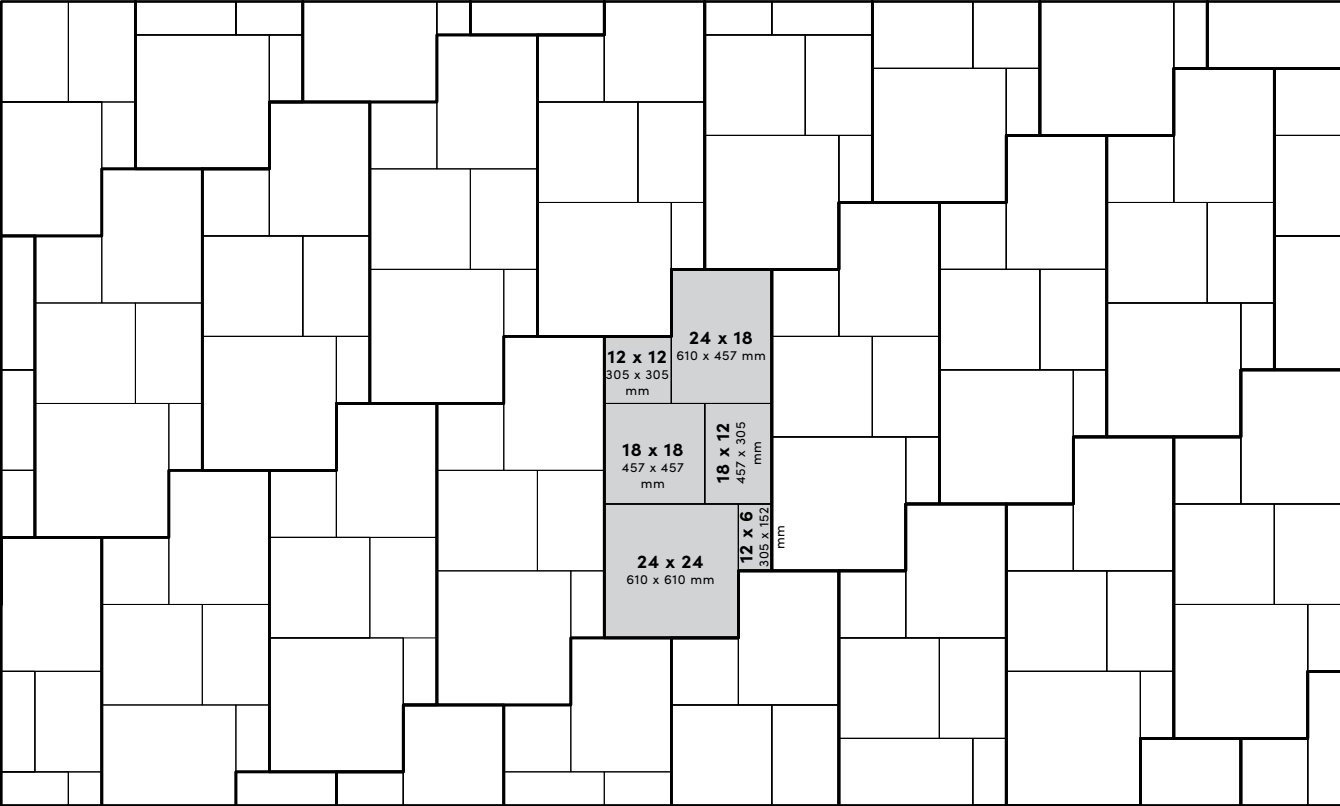

WALKWAY

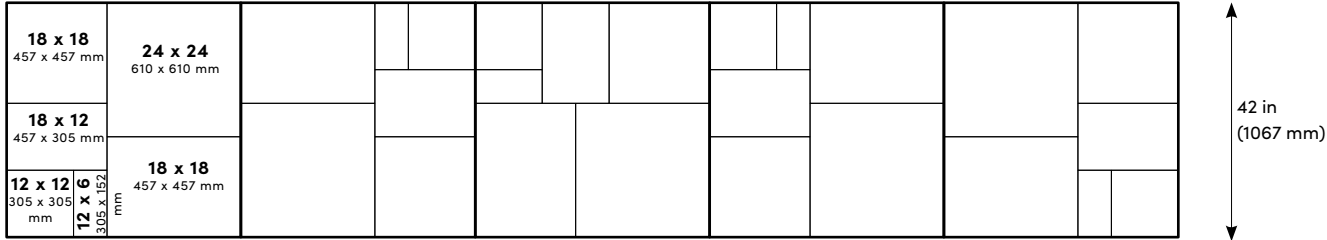

PAVERS & SLABS

INSTALLATION GUIDE

BEDDING SAND INSTALLATION

Using screed rails on the compacted granular base, apply bedding sand at a maximum thickness of 1 in (25mm). By using a screed board along the top of the screed rails, the bedding sand will level evenly. Bedding sand should be compacted since Dimensional Flagstone slabs should not be compacted after installation.

FLAGSTONE INSTALLATION

- Begin by laying the individual pieces of Dimensional Flagstone on the screeded bedding material according to your detailed project plan.
- Push flagstone slabs directly together so the bottom edges butt tight. There is no need to space the slabs to create the necessary joint. Joint is pre-set in the unit.
- Cut units as needed to finish edges of installation.
- **Note:** To ensure proper color distribution, mix layers from several bundles at one time.

JOINT SAND INSTALLATION

Once the flagstone pieces are installed, fill all joints with jointing sand suitable for large joints. Sweep the sand into the joints between flagstones until the joints are completely filled. Follow the jointing sand manufacturer's recommendations for wetting the sand. You may need to repeat this process with more dry sand in a few days to completely fill the joints between individual slabs.

CAUTION: Dimensional Flagstone slabs should not be compacted after installation.

OTHER CONSIDERATIONS

You may want to apply a sealer to protect the flagstone slabs from spills and stains. Always use a high quality sealer specifically formulated for wet-cast concrete.

Not suitable for vehicular traffic

GENERAL NOTES FOR DETAILS

This page shows a typical detail for Dimensional Flagstone.

- This drawing is for preliminary reference only (not for final construction).
- **Final designs for construction must be prepared by a registered professional engineer using the actual conditions of the proposed site and loads.**
- Block size and placement shown are for reference only, individual blocks vary with installation pattern and product.
- Section shown is the minimum recommendation for pedestrian loading. Projects with heavier traffic or sites with poor soil conditions may require thicker gravel base, concrete curb edge restraint, and/or sand subbase.
- Provide adequate surface drainage to prevent ponded water.

TYPICAL RESIDENTIAL INSTALLATION

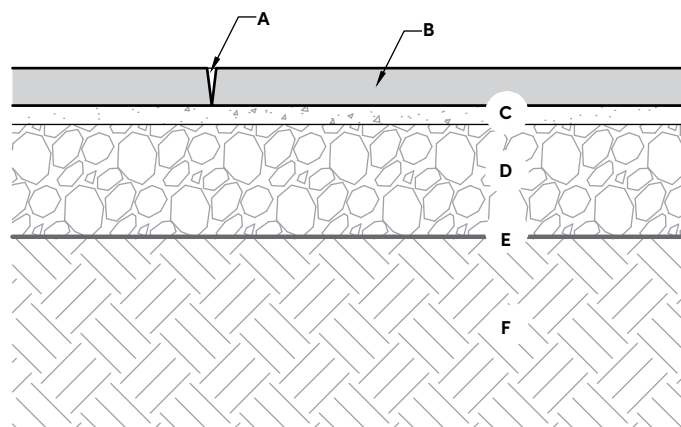

- A. Polymeric jointing sand between slabs
- B. Dimensional Slabs (2 in (51 mm) thick)
- C. Coarse bedding sand (1 in (25 mm) thick)
- D. Compacted gravel base (6 in (150 mm) thick)
- E. Woven geotextile (optional)
- F. Suitable, compacted subgrade



LINEAR FLAGSTONE

FEATURES

- Authentic, natural slate texture
- Uniform thickness and accurate dimensions translates into fast installation and a beautiful end result
- Great border option for Dimensional Flagstone

Notes:

*Colors & product availability vary by region.

PALLET

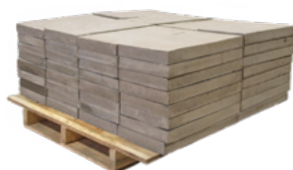

Weight: ±2,350 lb (±1,066 kg) (inc. pallet)
 Coverage: 98 sq ft (29.9 sq m)
 Layers Per Pallet: 8



UNIT	L x W x H
Dimensions:	21 x 10.5 x 2 in (533 x 267 x 51 mm)
Weight:	±37 lb (±17 kg)
Coverage:	1.53 sq ft (0.47 sq m)
Units Per Pallet:	64

PATTERNS

RUNNING BOND

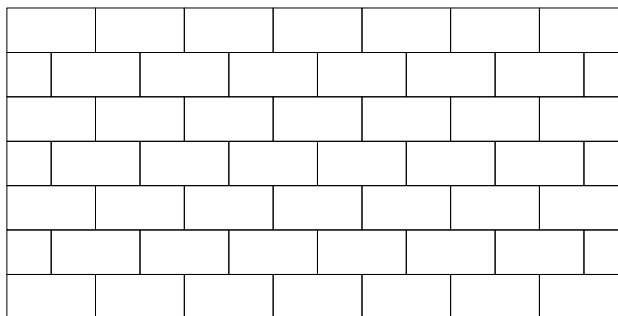

HERRINGBONE

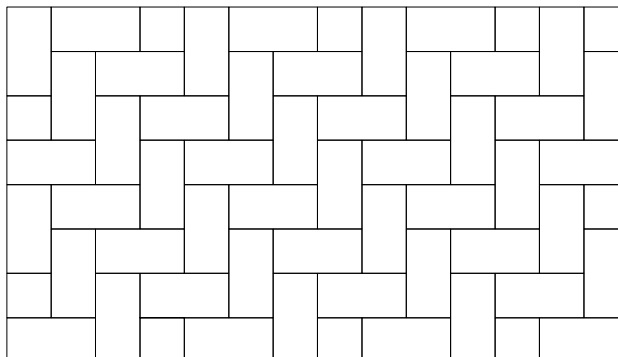

INSTALLATION GUIDE

BEDDING SAND INSTALLATION

Using screed rails on the compacted granular base, apply bedding sand at a maximum thickness of 1 in (25mm). By using a screed board along the top of the screed rails, the bedding sand will level evenly. Bedding sand should be compacted since Linear Flagstone slabs should not be compacted after installation.

FLAGSTONE INSTALLATION

- Begin by laying the individual pieces of Linear Flagstone on the screeded bedding material according to your detailed project plan.
- Push flagstone slabs directly together so the bottom edges butt tight. There is no need to space the slabs to create the necessary joint. Joint is pre-set in the unit.
- Cut units as needed to finish edges of installation.
- **Note: To ensure proper color distribution, mix layers from several bundles at one time.**

JOINT SAND INSTALLATION

Once the flagstone pieces are installed, fill all joints with jointing sand suitable for large joints. Sweep the sand into the joints between flagstones until the joints are completely filled. Follow the jointing sand manufacturer’s recommendations for wetting the sand. You may need to repeat this process with more dry sand in a few days to completely fill the joints between individual slabs.

CAUTION: Linear Flagstone slabs should not be compacted after installation.

OTHER CONSIDERATIONS

You may want to apply a sealer to protect the flagstone slabs from spills and stains. Always use a high quality sealer specifically formulated for wet-cast concrete.

Not suitable for vehicular traffic.

GENERAL NOTES FOR DETAILS

This page shows a typical detail for Linear Flagstone.

- This drawing is for preliminary reference only (not for final construction).
- **Final designs for construction must be prepared by a registered professional engineer using the actual conditions of the proposed site and loads.**
- Block size and placement shown are for reference only, individual blocks vary with installation pattern and product.
- Section shown is the minimum recommendation for pedestrian loading. Projects with heavier traffic or sites with poor soil conditions may require thicker gravel base, concrete curb edge restraint, and/or sand subbase.
- Provide adequate surface drainage to prevent ponded water.

TYPICAL RESIDENTIAL INSTALLATION

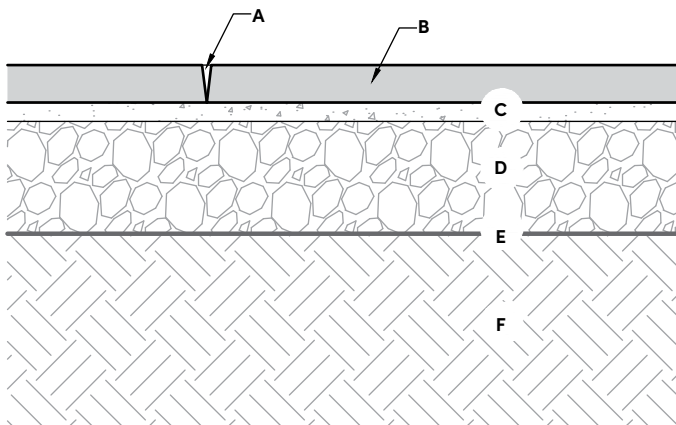

- A. Polymeric jointing sand between slabs
- B. Linear Slabs (2 in (51 mm) thick)
- C. Coarse bedding sand (1 in (25 mm) thick)
- D. Compacted gravel base (6 in (150 mm) thick)
- E. Woven geotextile (optional)
- F. Suitable, compacted subgrade



24 x 24 Flagstone

FEATURES

- Authentic, natural slate texture
- Consistent 2 in (51 mm) thickness
- Uniform thickness and accurate dimensions makes for fast installation and a beautiful end result
- Optimal for rooftop pedestal installations

Notes:

*Colors & product availability vary by region.

PALLET



Weight: ±1,600 lb (±726 kg) (inc. pallet)
 Coverage: 64 sq ft (5.9 sq m)
 Layers Per Pallet: 8



UNIT	L x W x H
Dimensions:	24 x 24 x 2 in (610 x 610 x 51 mm)
Weight:	±96 lbs (±44 kg)
Units Per Pallet:	16

PATTERNS

STACK BOND

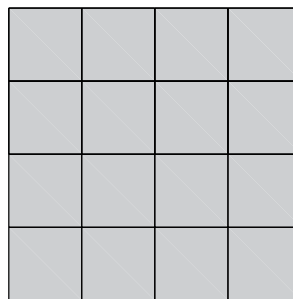

RUNNING BOND

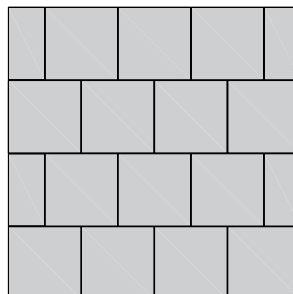

INSTALLATION GUIDE

BEDDING SAND INSTALLATION

Using screed rails on the compacted granular base, apply bedding sand at a maximum thickness of 1 in (25mm). By using a screed board along the top of the screed rails, the bedding sand will level evenly. Bedding sand should be compacted since Linear Flagstone slabs should not be compacted after installation.

FLAGSTONE INSTALLATION

- Begin by laying the individual pieces of 24 x 24 Flagstone on the screeded bedding material according to your detailed project plan.
- For on-grade installations, 24 x 24 Flagstone slabs must not be abutted directly together at the edges. It is recommended to install the pavers with a minimum gap of 1/8 inch (3 mm) apart between all sides. This gap could be accomplished using wooden shims or tile spacers of the correct width.
- Cut units as needed to finish edges of installation.
- **Note:** To ensure proper color distribution, mix layers from several bundles at one time.

JOINT SAND INSTALLATION

Once the flagstone pieces are installed, fill all joints with jointing sand suitable for large joints. Sweep the sand into the joints between flagstones until the joints are completely filled. Follow the jointing sand manufacturer's recommendations for wetting the sand. You may need to repeat this process with more dry sand in a few days to completely fill the joints between individual slabs.

CAUTION: 24x24 Flagstone slabs should not be compacted after installation.

OTHER CONSIDERATIONS

You may want to apply a sealer to protect the flagstone slabs from spills and stains. Always use a high quality sealer specifically formulated for wet-cast concrete.

Not suitable for vehicular traffic

GENERAL NOTES FOR DETAILS

This page shows a typical detail for 24 x 24 Flagstone.

- This drawing is for preliminary reference only (not for final construction).
- **Final designs for construction must be prepared by a registered professional engineer using the actual conditions of the proposed site and loads.**
- Block size and placement shown are for reference only, individual blocks vary with installation pattern and product.
- Section shown is the minimum recommendation for pedestrian loading. Projects with heavier traffic or sites with poor soil conditions may require thicker gravel base, concrete curb edge restraint, and/or sand subbase.
- Provide adequate surface drainage to prevent ponded water.

TYPICAL RESIDENTIAL INSTALLATION

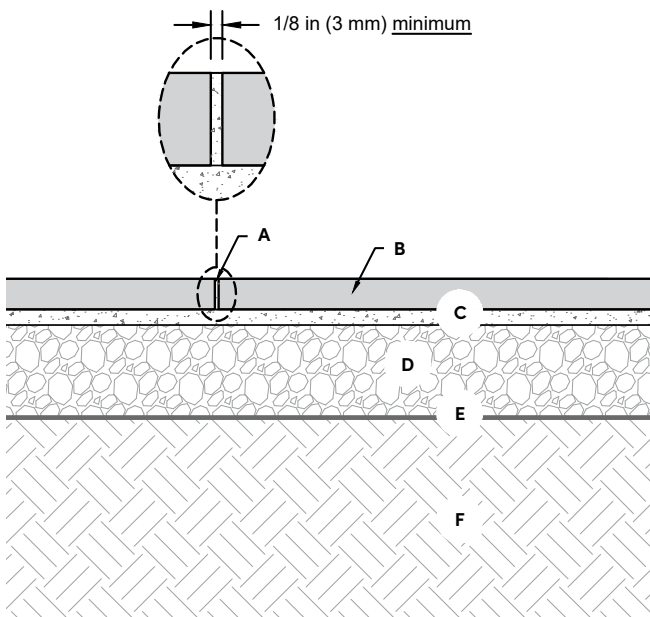

- Polymeric jointing sand between slabs. Space slabs a minimum of 1/8 in (3 mm).
- 24 x 24 Flagstone slabs (2 in (51 mm) thick)
- Coarse bedding sand (1 in (25 mm) thick)
- Compacted gravel base (6 in (150 mm) thick)
- Woven geotextile (optional)
- Suitable, compacted subgrade

MIROS

FEATURES

- Large format slab with thermalled stone texture
- Clean, crisp lines perfect for formal or modern applications
- Lends itself well to moss or stone in joints
- Fast, mechanical installation

Notes:

*Colors & product availability vary by region.

PALLET



Weight: ±3,600 lb (±1,633 kg) (inc. pallet)
 Coverage: 73.5 sq ft (22.4 sq m)
 Layers Per Pallet: 6
 Section: 12.25 sq ft (3.7 sq m) per piece

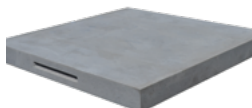

UNIT	L x W x H
Dimensions:	42 x 42 x 4 in (1067 x 1067 x 102 mm)
Weight:	±600 lb (±272 kg)
Coverage:	12.25 sq ft (3.7 sq m)
Units Per Pallet:	6

PATTERNS

STACK BOND

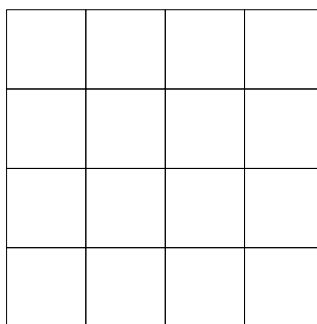

STACK BOND (4 in (102 mm) JOINT)

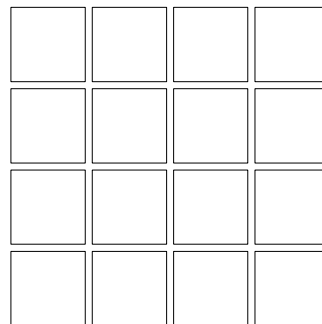

RUNNING BOND

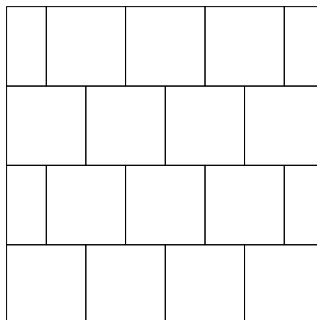

RUNNING BOND (4 in (102 mm) JOINT)

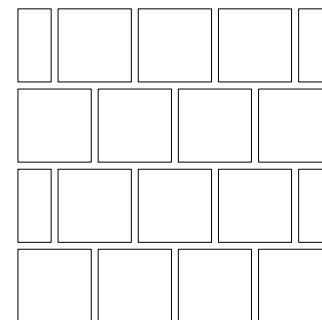

GENERAL NOTES FOR DETAILS

This page shows typical details for Miros Slabs.

- These drawings are for preliminary reference only (not for final construction).
- Final designs for construction must be prepared by a registered professional engineer using the actual conditions of the proposed site and loads.
- Block size and placement shown are for reference only.

MIROS DETAIL WITH TIGHT JOINT (REQUIRES VACUUM INSTALLATION)

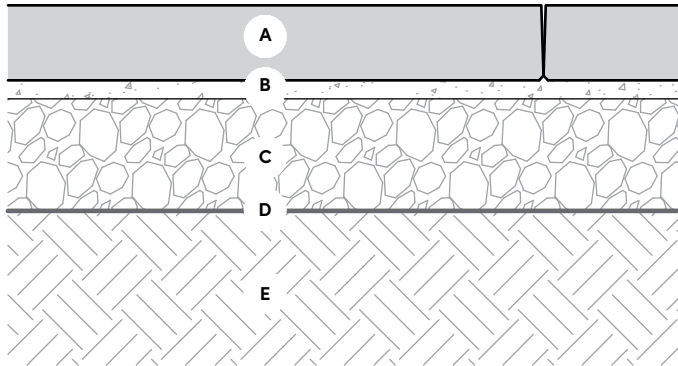

- A. Miros slabs (4 in (102 mm) thick)
- B. Coarse bedding sand (1 in (25 mm) thick)
- C. Compacted gravel base (minimum 6 in (150 mm) thick)
- D. Woven geotextile (as required)
- E. Compacted existing subgrade

MIROS DETAIL WITH 4 in (102 MM) JOINT

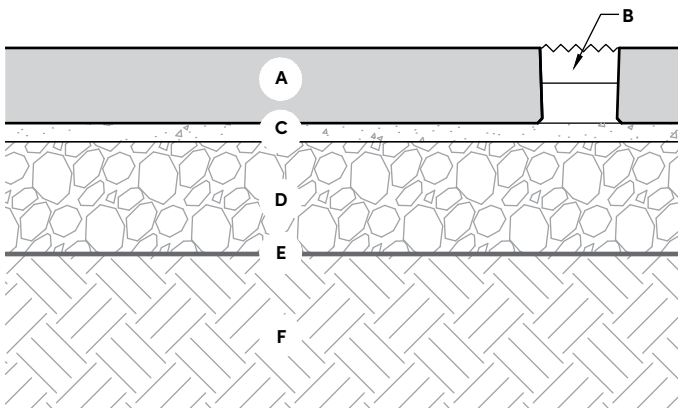

- A. Miros slabs (4 in (102 mm) thick)
- B. 4 in (102 mm) joint (to be filled with decorative stone, turf, or accent pavers)
- C. Coarse bedding sand (1 in (25 mm) thick)
- D. Compacted gravel base (minimum 6 in (150 mm) thick)
- E. Woven geotextile (as required)
- F. Compacted existing subgrade



MIROS LIFTING DEVICE

Contact Rosetta or a local dealer for use.



NEW MISSION

FEATURES

- A combination of modern and Romanesque, with a smaller surface area
- Tighter joints for non-permeable applications
- Three sizes and multiple face textures
- Suitable for residential vehicular traffic

Notes:

*Colors & product availability vary by region.

PALLET



Weight:	±3,050 lb (±1,383 kg) (inc. pallet)
Coverage:	100 sq ft (30.5 sq m)
Linear Feet (Soldier Course):	140 ft (42.7 m)
Layers Per Pallet:	8
Section:	12.5 sq ft (3.8 m) per layer



UNIT: 6 x 9 in (152 x 229 mm)

Dimensions:	5.3 x 8.5 x 2.75 in (144 x 216 x 70 mm)
Weight:	±10 lb (±4.5 kg)
Coverage:	.33 sq ft (0.10 sq m)
Units Per Pallet:	80



UNIT: 9 x 9 in (229 x 229 mm)

Dimensions:	8.5 x 8.5 x 2.75 in (216 x 216 x 70 mm)
Weight:	±15 lb (±6.8 kg)
Coverage:	.5 sq ft (0.15 sq m)
Units Per Pallet:	40



UNIT: 9 x 12 in (229 x 305 mm)

Dimensions:	11.3 x 8.5 x 2.75 in (287 x 216 x 70 mm)
Weight:	±20 lb (±9.1 kg)
Coverage:	.66 sq ft (0.20 sq m)
Units Per Pallet:	80

PATTERN

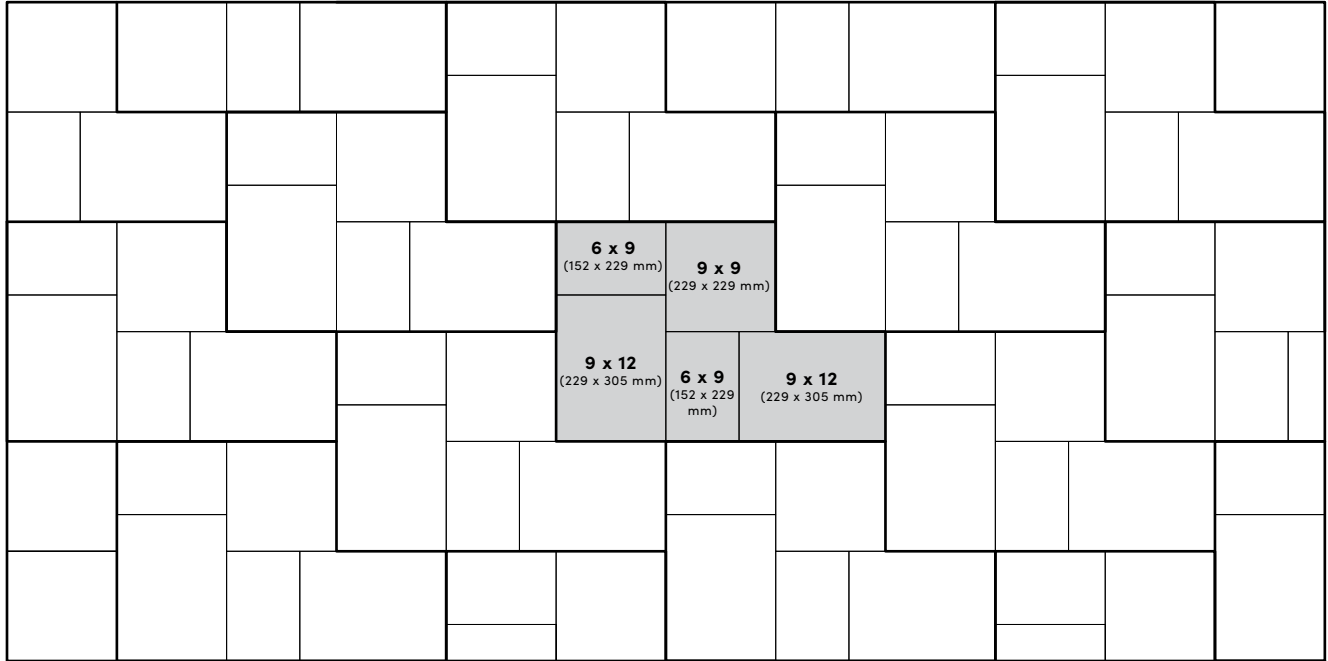

BORDER PATTERN

Each size paver has a 9 in (229 mm) side. Run these sides end-over-end to create a soldier course to border your driveway, patio and walkways. For added aesthetic value, use a different color paver for the soldier course.

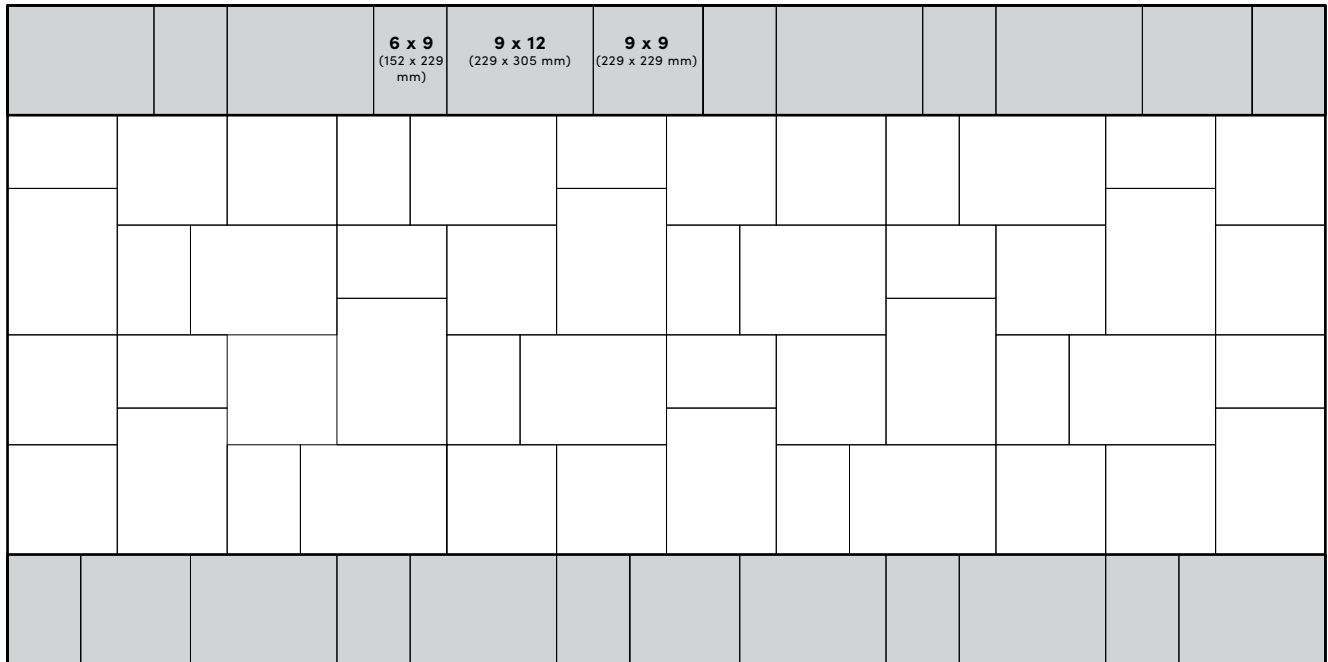

GENERAL NOTES FOR DETAILS

This page shows typical details for New Mission pavers.

- These drawings are for preliminary reference only (not for final construction).
- Final designs for construction must be prepared by a registered professional engineer using the actual conditions of the proposed site and loads.
- Block size and placement shown are for reference only.
- Sections shown are the minimum recommendations.
- Adequate surface drainage should be provided to prevent ponded water.
- These sections are not intended for permeable pavement applications.
- When snowplowing New Mission Pavers, a poly cutting edge must be used to avoid marking the surface of the paver.

TYPICAL PEDESTRIAN AND RESIDENTIAL VEHICULAR DETAIL

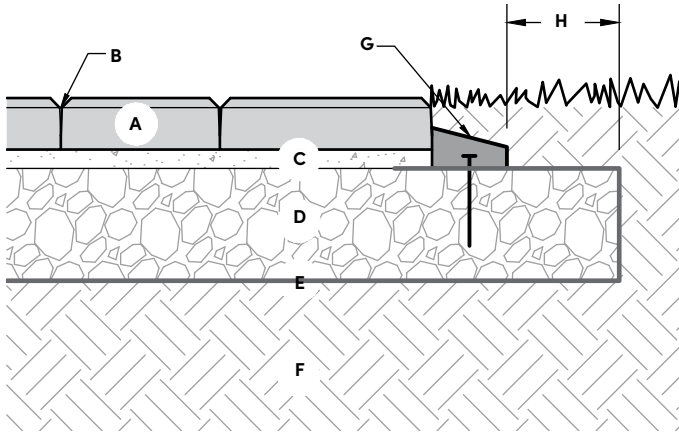

- A. New Mission pavers (2.75 in (70 mm) thick)
- B. Polymeric jointing sand between pavers
- C. Bedding sand, ASTM C33, <1% finer than 0.075 mm (1 in (25 mm) thick)
- D. Compacted dense-graded gravel base (minimum 6 in (152 mm) thick)
- E. Woven geotextile (as required)
- F. Compacted suitable subgrade
- G. Plastic or metal edging strip
- H. 6 in (152 mm) minimum

Commercial projects with vehicular traffic or sites with poor soil conditions may require thicker gravel base, concrete curb edge restraint, and/or sand subbase.

TYPICAL LIGHT COMMERCIAL VEHICULAR DETAIL

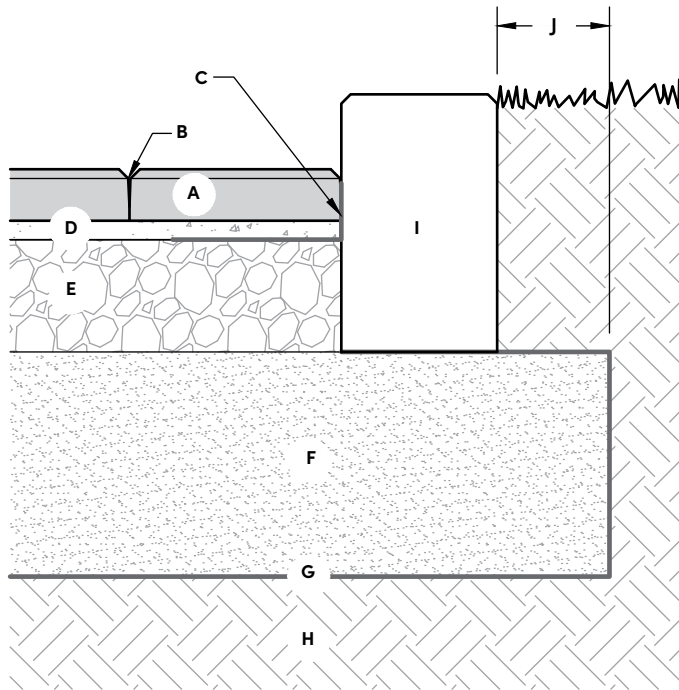

- A. New Mission pavers (2.75 in (70 mm) thick)
- B. Polymeric jointing sand between pavers
- C. 12 in (305 mm) wide geotextile turned up against curb
- D. Bedding sand, ASTM C33, <1% finer than 0.075 mm (1 in (25 mm) thick)
- E. Compacted dense-graded gravel base (minimum 8 in (203 mm) thick)
- F. Free-draining sand subbase (minimum 12 in (305 mm) thick, if required)
- G. Woven geotextile (as required)
- H. Compacted suitable subgrade
- I. Cast-in-place concrete edging or curb
- J. 6 in (152 mm) minimum

Section is suitable for vehicular applications assuming <100,000 equivalent single axle loads (ESALs), competent subgrade with California bearing ratio (CBR) >5, and low speeds (<25 mph (40 kph)).

Subgrade preparation, subbase requirements, and subsurface draining requirement should be determined by the project geotechnical engineer.

OLD MISSION

FEATURES

- Cobblestone influence with wider joints for permeable applications
- Three sizes and multiple face textures
- Suitable for residential vehicular traffic

Notes:

*Colors & product availability vary by region.

PALLET



Weight:	±3,050 lb (±1,383 kg) (inc. pallet)
Coverage:	100 sq ft (30.5 sq m)
Linear Feet (Soldier Course):	140 ft (42.7 m)
Layers Per Pallet:	8
Section:	12.5 sq ft (3.8 m) per layer



UNIT: 6 x 9 in (152 x 229 mm)

Dimensions:	5.3 x 8.5 x 2.75 in (144 x 216 x 70 mm)
Weight:	±10 lb (±4.5 kg)
Coverage:	.33 sq ft (0.10 sq m)
Units Per Pallet:	80



UNIT: 9 x 9 in (229 x 229 mm)

Dimensions:	8.5 x 8.5 x 2.75 in (216 x 216 x 70 mm)
Weight:	±15 lb (±6.8 kg)
Coverage:	.5 sq ft (0.15 sq m)
Units Per Pallet:	40



UNIT: 9 x 12 in (229 x 305 mm)

Dimensions:	11.3 x 8.5 x 2.75 in (287 x 216 x 70 mm)
Weight:	±20 lb (±9.1 kg)
Coverage:	.66 sq ft (0.20 sq m)
Units Per Pallet:	80

PATTERN

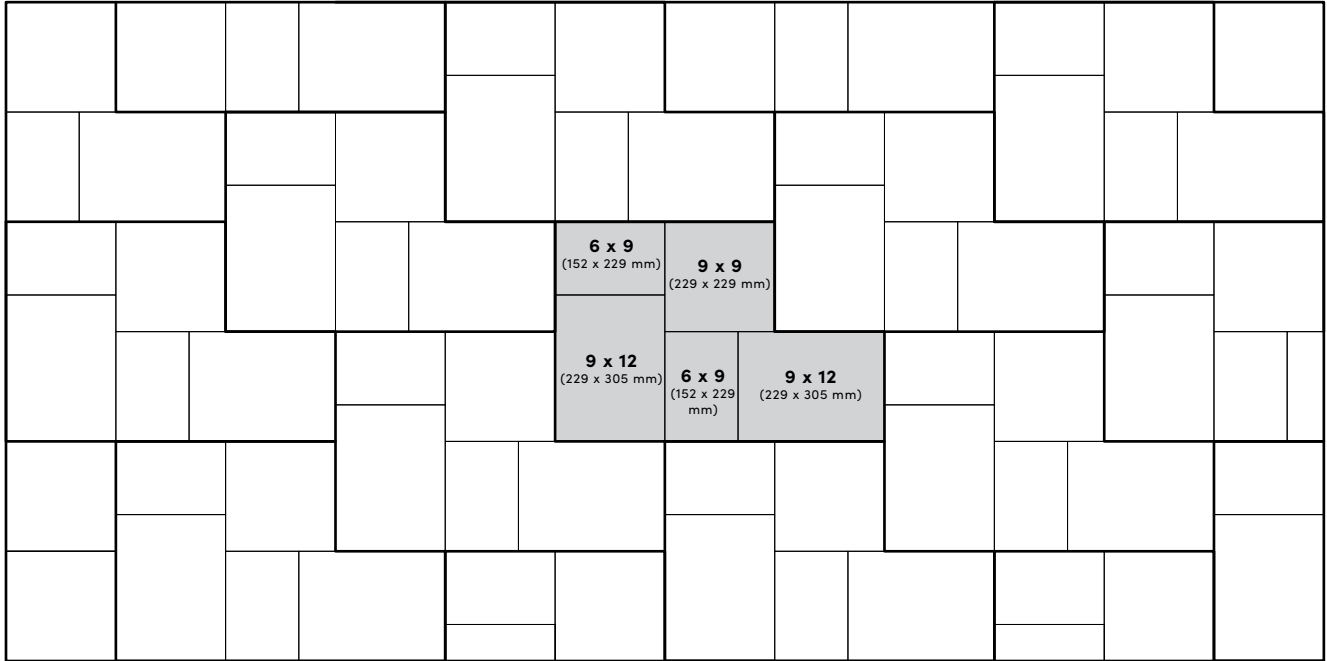

BORDER PATTERN

Each size paver has a 9 in (229 mm) side. Run these sides end-over-end to create a soldier course to border your driveway, patio, and walkways. For added aesthetic value, use a different color paver for the soldier course.

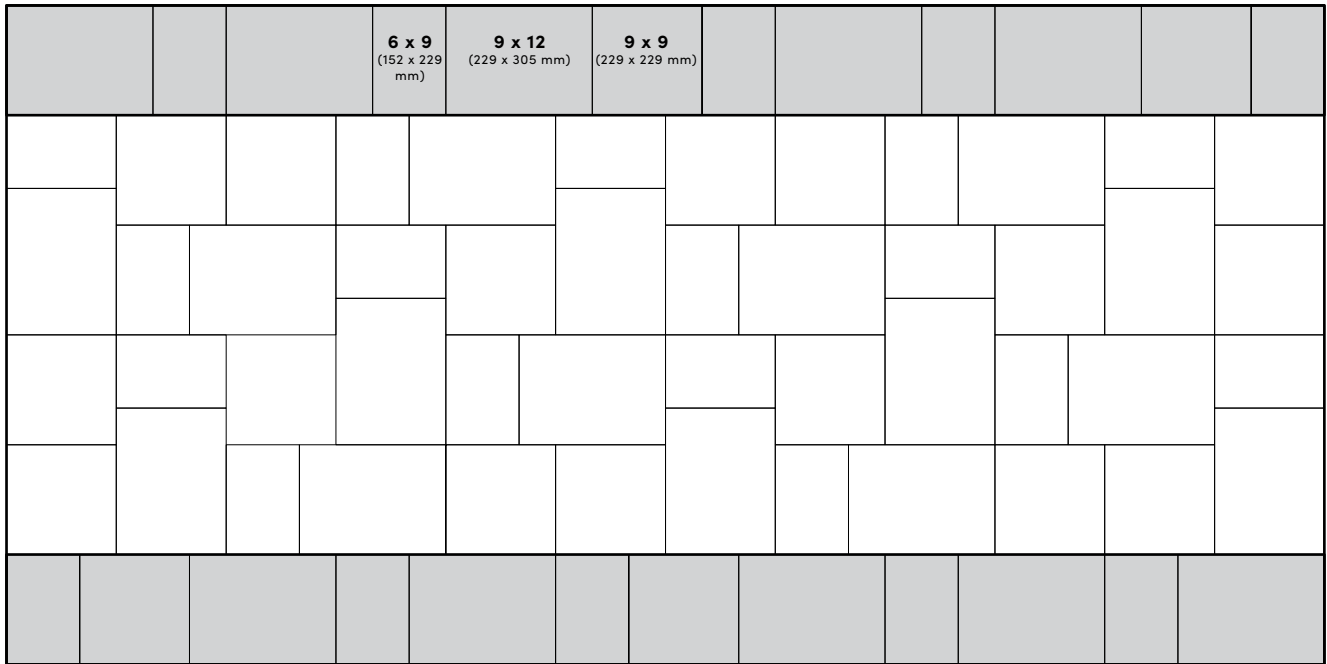

GENERAL NOTES FOR DETAILS

This page shows typical details for Old Mission pavers.

- This drawing is for preliminary reference only (not for final construction).
- Final designs for construction must be prepared by a registered professional engineer using the actual conditions of the proposed site and loads.
- Block size and placement shown are for reference only.
- Section shown is based on minimum ICPI recommendations.
- Subbase and base thicknesses, edge restraint, and drainage details vary depending on project requirements.
- Long-term performance requires routine maintenance to maintain permeability.
- When snowplowing Old Mission pavers, a poly cutting edge must be used to avoid marking the surface of the paver.

TYPICAL PERMEABLE PEDESTRIAN VEHICULAR DETAIL

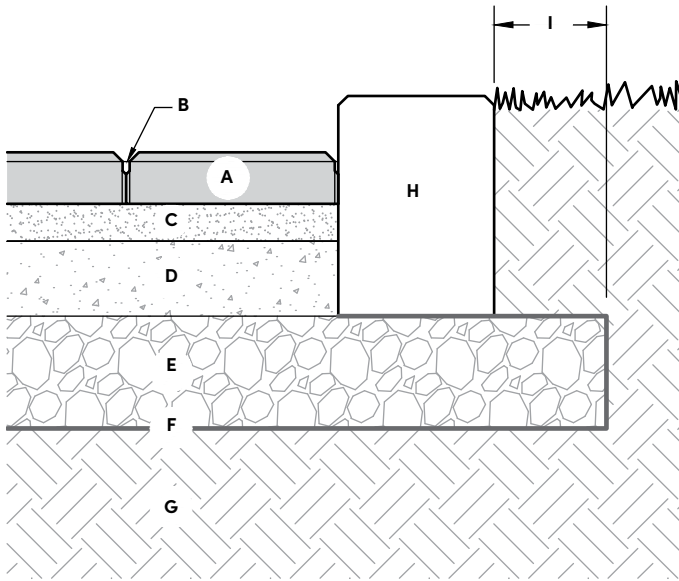

- A. Old Mission pavers (2.75 in (70 mm) thick)
- B. Clear chip stone, 3/8 in (9.5 mm) or less between pavers
- C. Open graded bedding course (ASTM No. 8 aggregate, 2 in (51 mm) thick)
- D. Open graded base course (ASTM No. 57 stone, 4 in (102 mm) thick)
- E. Open graded subbase course (ASTM No. 2 stone, 6 in (152 mm) thick)
- F. Woven geotextile (as specified by Engineer)
- G. Suitable subgrade
- H. Cast-in-Place concrete edging or curb, where subject to vehicular traffic
- I. 6 in (152 mm) minimum



AMARO

FEATURES

- Twelve textures provide a reclaimed brick aesthetic with consistent quality
- Rich, bold colors create perfect accents to make every project pop
- The paver can be placed with one hand to speed up installation
- Suitable for residential vehicular traffic

Notes:

*Colors & product availability vary by region.

PALLET



Weight:	±2,300 lb (±1,043 kg) (inc. pallet)
Coverage:	72 sq ft (22 sq m)
Linear Feet (Soldier Course):	96 ft (29 m)
Linear Feet (Sailor Course):	288 ft (88 m)
Layers Per Pallet:	8
Pavers Per Layer:	48



UNIT	L x W x H
Dimensions:	9 x 3 x 2.75 in (229 x 76 x 70 mm)
Weight:	±6 lb (±3 kg)
Coverage:	.1875 sq ft (0.057 sq m)
Units Per Pallet:	384

PATTERNS

1/2 RUNNING BOND

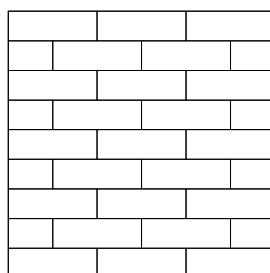

1/3 RUNNING BOND

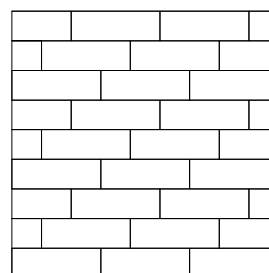

HERRINGBONE

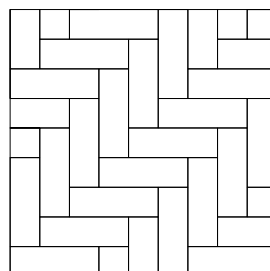

BASKETWEAVE

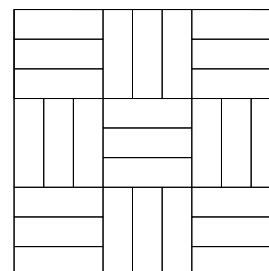

GENERAL NOTES FOR DETAILS

This page shows typical details for Amaro pavers.

- This drawing is for preliminary reference only (not for final construction).
- Final designs for construction **must be prepared by a registered professional engineer** using the actual conditions of the proposed site and loads.
- Block size and placement shown are for reference only.
- Sections shown are the minimum recommendations for residential drives and pedestrian loading.
- Commercial projects with vehicular traffic or sites with poor soil conditions may require thicker gravel base, concrete curb edge restraint, and/or sand subbase.
- Adequate surface drainage should be provided to prevent ponded water.
- These sections are not intended for permeable pavement applications.
- When snowplowing Amaro pavers, a poly cutting edge must be used to avoid marking the surface of the paver.

TYPICAL PEDESTRIAN AND RESIDENTIAL VEHICULAR DETAIL

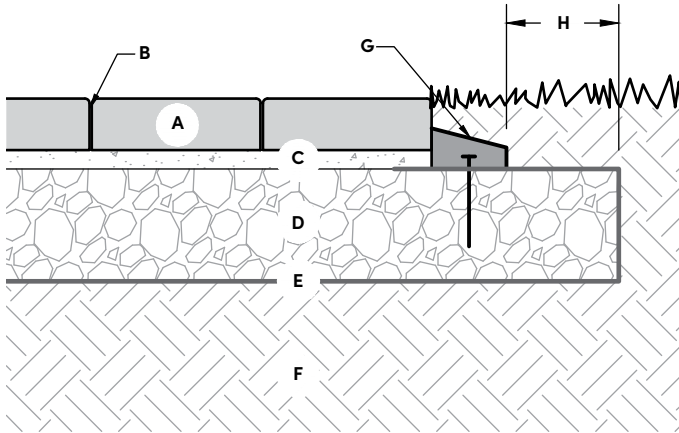

- A. Amaro pavers (2.75 in (70 mm) thick)
- B. Polymeric jointing sand between pavers
- C. Bedding sand, ASTM C33, <1% finer than 0.075 mm (1 in (25 mm) thick)
- D. Compacted dense-graded gravel base (minimum 6 in (152 mm) thick)
- E. Woven geotextile (as required)
- F. Compacted suitable subgrade
- G. Plastic or metal edging strip
- H. 6 in (152 mm) minimum

BORDO

FEATURES

- A natural cleft on stone top
- 32 different textures 16 pieces of two sizes
- Very easy to install with manageable sizes and known sizes
- Consistent 3-5/8" heights

Notes:

*Colors & product availability vary by region.

PALLET



Weight:	±1,522 lb (±690 kg) (inc. pallet)
Linear Feet:	112 Ln ft (34 Ln m)
Layers Per Pallet:	4
One Layer:	28 Ln ft (8.5 Ln m)
One Set:	3.5 Ln ft (1.1 Ln m)



UNIT: 18 x 4 in (457 x 102 mm)

Dimensions:	18 x 4 x 3.625 in (457 x 102 x 92 mm)
Weight:	±20 lb (±9 kg)
Coverage:	.1875 sq ft (.057 sq m)
Units Per Pallet:	384



UNIT: 24 x 4 in (610 x 102 mm)

Dimensions:	24 x 4 x 3.625 in (610 x 102 x 92 mm)
Weight:	±27 lb (±12 kg)
Coverage:	.1875 sq ft (.057 sq m)
Units Per Pallet:	384

SUPERIOR STEPPERS

FEATURES

- Eight different shapes for a rustic, authentic stone appearance
- Various color offerings compliment your existing backyard environment

Notes:

*Colors & product availability vary by region.

PALLET



Weight: ±1,300 lb (±590 kg) (inc. pallet)
 Coverage: 52 sq ft (15.8 sq m)
 Pieces Per Pallet: 16 (random assortment)
 Section: 3.25 sq ft (0.99 sq m) per 1 piece



UNIT: 1 L x W x H
 Dimensions: 27 x 21 x 2 in (686 x 533 x 51 mm)
 Weight: ±78 lb (±35 kg)
 Coverage: 3.25 sq ft (0.99 sq m)



UNIT: 2
 Dimensions: 27 x 21 x 2 in (686 x 533 x 51 mm)
 Weight: ±78 lb (±35 kg)
 Coverage: 3.25 sq ft (0.99 sq m)



UNIT: 3
 Dimensions: 27 x 21 x 2 in (686 x 533 x 51 mm)
 Weight: ±78 lb (±35 kg)
 Coverage: 3.25 sq ft (0.99 sq m)



UNIT: 4
 Dimensions: 27 x 21 x 2 in (686 x 533 x 51 mm)
 Weight: ±78 lb (±35 kg)
 Coverage: 3.25 sq ft (0.99 sq m)



UNIT: 5
 Dimensions: 27 x 21 x 2 in (686 x 533 x 51 mm)
 Weight: ±78 lb (±35 kg)
 Coverage: 3.25 sq ft (0.99 sq m)



UNIT: 6
 Dimensions: 27 x 21 x 2 in (686 x 533 x 51 mm)
 Weight: ±78 lb (±35 kg)
 Coverage: 3.25 sq ft (0.99 sq m)



UNIT: 7
 Dimensions: 27 x 21 x 2 in (686 x 533 x 51 mm)
 Weight: ±78 lb (±35 kg)
 Coverage: 3.25 sq ft (0.99 sq m)



UNIT: 8
 Dimensions: 27 x 21 x 2 in (686 x 533 x 51 mm)
 Weight: ±78 lb (±35 kg)
 Coverage: 3.25 sq ft (0.99 sq m)

SUPERIOR STEPPERS

GENERAL NOTES FOR DETAILS

This page shows a typical detail for Superior Steppers.

- This drawing is for preliminary reference only (not for final construction).
- Block size and placement shown are for reference only, individual steps vary with installation pattern.

TYPICAL INSTALLATION

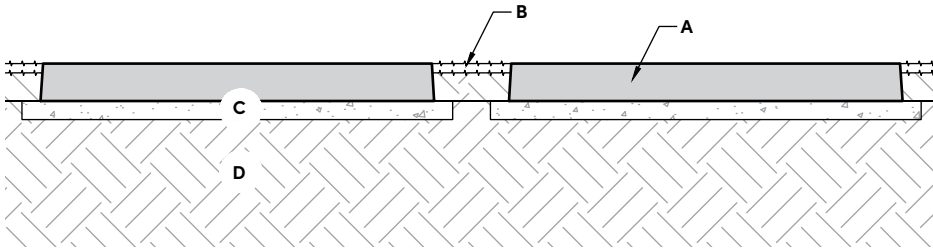

- A. Superior Stepper stone (2 in (50 mm) thick)
- B. Turf between Superior Stepper stones
- C. Coarse bedding sand min. 1 in (25 mm) thick compacted
- D. Compacted existing sub-grade

STEPS

GENERAL INFORMATION
IRREGULAR
DIMENSIONAL



INSTALLATION GUIDE

BASIC STEP INSTALLATION NOTES FOR:

- Irregular
- Dimensional

Refer to product pages for specific information and details pertaining to individual products.

MEASUREMENTS

Begin the step installation process by measuring the total rise required and calculating the number of steps to be used. Each step has a 5-1/2 in (140 mm) or 7 in (178 mm) rise, but should be sloped approximately 1/2 in (13 mm) such that the back of the step is higher than the front of the step. This slope will facilitate surface water drainage. With appropriate sloping, the net rise of each step is 6 in (152 mm) or 7-1/2 in (191 mm). Divide the total rise by 6 in (152 mm) or 7-1/2 in (191 mm) to get the number of steps required.

CALCULATIONS

Next, calculate the tread width. Generally, when the grade allows, a 12 in (305 mm) or wider tread is desirable. To calculate the tread width, divide the total allowable horizontal run minus the width of the top step, by the number of steps minus one. The one less will account for the top step.

CONSIDER THE FOLLOWING EXAMPLE:

Total rise = 42 in, Total horizontal run = 108 in, Width of top step = 24 in, Rise of steps = 5-1/2 in

Number of steps = 42 in ÷ 6 in/Step = 7 Steps

Tread Depth = (108 in-24 in) ÷ (7-1) = 14 in Tread Depth

Metric Calculation:

Total rise = 1067 mm, Total horizontal run = 2743 mm, Width of top step = 610 mm, Rise of steps = 140 mm

Number of steps = 1067 mm ÷ 152 mm/step = 7 steps

Tread depth = (2743 mm-610 mm) ÷ (7-1) = 356 mm tread depth

EXCAVATION

Excavate and grade the area for the first step. Steps should be placed on at least 3 in (76 mm) of free draining soil, such as sand or pea-stone. Compact soil to a minimum of 95% Standard Proctor.

PLACEMENT

Place step with either forks or straps using a small excavator or skid-steer to lift the piece into place. Practice safe handling procedures during this process.

FILL

Fill behind each step with free draining soil and compact to 95% standard proctor. Remember to slope fill to allow for proper drainage when next step is placed. Continue placing steps in this manner until finish grade is reached.

GENERAL NOTES FOR STEP SECTION

This page shows a typical detail for steps.

- This drawing is for preliminary reference only (not for final construction).
- Final designs for construction **must be prepared by a registered professional engineer** using the actual conditions of the proposed site and loads.
- Block size and placement shown are for reference only, individual steps vary with installation pattern.

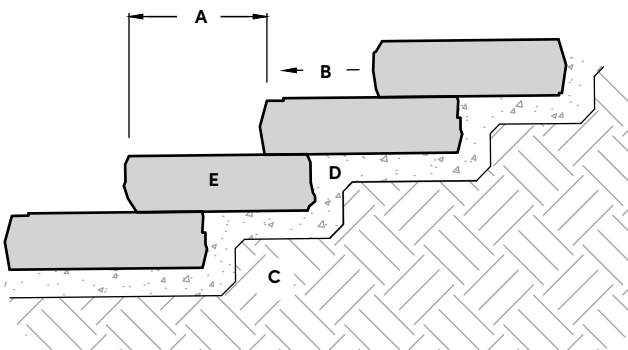

- A. Tread width varies (12 in (305 mm) or more is desirable)
- B. Slope 1-2% (to allow drainage)
- C. Compact subbase material to a minimum of 95% max. dry density (or as specified by engineer)
- D. Free-draining granular material (3 in (76 mm) thick minimum compact to a min. of 95% max. dry density)
- E. Step block



IRREGULAR

FEATURES

- Stone-like shapes and textures create inviting walkways
- Consistent rise equals fast installation and safe end result
- Quality materials and long term durability
- Multiple natural color blends available
- Complimentary products offer a variety of creative possibilities

Notes:

*Colors & product availability vary by region.
Individual steps cannot be requested, the pallets come in a random assortment.
All dimensions are nominal.

LARGE 6 ft PALLET (1.8 m)



Weight: ±3,900 lb (±1,769 kg) (inc. pallet)
Pieces Per Pallet: 3 (random assortment)

SNAPPED FACE



Side A



Side B



UNIT: 1 L x W x H
Dimensions: 72 x 30 x 7 in (1829 x 762 x 178 mm)
Weight: ±1,300 lb (±590 kg)

Side A



Side B



UNIT: 2
Dimensions: 72 x 30 x 7 in (1829 x 762 x 178 mm)
Weight: ±1,300 lb (±590 kg)

Side A



Side B



UNIT: 3
Dimensions: 72 x 30 x 7 in (1829 x 762 x 178 mm)
Weight: ±1,300 lb (±590 kg)

IRREGULAR

STANDARD 7 in RISE PALLET (178 mm)



Weight: $\pm 4,200$ lb ($\pm 1,905$ kg) (inc. pallet)
Pieces Per Pallet: 8 (random assortment)

WEATHERED FACE



UNIT: A L x W x H
Dimensions: 54 x 24 x 7 in (1372 x 610 x 178 mm)
Weight: ± 458 lb (± 208 kg)



UNIT: B
Dimensions: 60 x 24 x 7 in (1524 x 610 x 178 mm)
Weight: ± 600 lb (± 272 kg)



UNIT: C
Dimensions: 42 x 17 x 7 in (1067 x 432 x 178 mm)
Weight: ± 349 lb (± 158 kg)



UNIT: D
Dimensions: 48 x 28 x 7 in (1219 x 711 x 178 mm)
Weight: ± 567 lb (± 257 kg)



UNIT: E
Dimensions: 42 x 26 x 7 in (1067 x 660 x 178 mm)
Weight: ± 476 lb (± 216 kg)



UNIT: F
Dimensions: 48 x 24 x 7 in (1219 x 610 x 178 mm)
Weight: ± 512 lb (± 232 kg)

Individual steps cannot be requested, the pallets come in a random assortment.

All dimensions are nominal.



DIMENSIONAL

FEATURES

- Stone-like shapes and textures create inviting walkways
- Consistent rise equals fast installation and safe end result
- Quality materials and long-term durability
- Multiple natural color blends available
- Complimentary products offer a variety of creative possibilities

Notes:

*Colors & product availability vary by region.

3 ft PALLET (0.9 m)

Weight: $\pm 3,050$ lb ($\pm 1,384$ kg) (inc. pallet)
Pieces Per Pallet: 8



UNIT L x W x H
Dimensions: 36 x 18 x 7 in (914 x 457 x 178 mm)
Weight: ± 375 lb (± 170 kg)

GUILLOTINE FACE

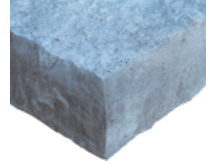

4 ft PALLET (1.2 m)

Weight: $\pm 4,050$ lb ($\pm 1,837$ kg) (inc. pallet)
Pieces Per Pallet: 8



UNIT L x W x H
Dimensions: 48 x 18 x 7 in (1219 x 457 x 178 mm)
Weight: ± 500 lb (± 227 kg)

SNAPPED FACE

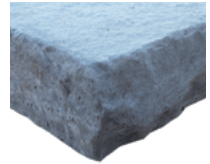

4 ft XL PALLET (1.2 m)

Weight: $2,750 \pm$ lb ($1247 \pm$ kg) (inc. pallet)
Pieces Per Pallet: 4



UNIT L x W x H
Dimensions: 48 x 24 x 7 in (1219 x 610 x 178 mm)
Weight: ± 675 lb (± 306 kg)

CHISELED FACE



6 ft PALLET (1.8 m)

Weight: $\pm 4,000$ lb ($\pm 1,814$ kg) (inc. pallet)
Pieces Per Pallet: 3



UNIT L x W x H
Dimensions: 72 x 30 x 7 in (1828 x 762 x 178 mm)
Weight: $\pm 1,320$ lb (± 599 kg)

SNAPPED FACE

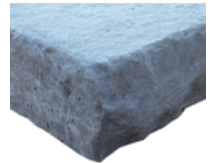

FIRE FEATURES

GENERAL INFORMATION

BELVEDERE FIRE PIT

DIMENSIONAL FIRE PIT

KODAH FIRE PIT

DIMENSIONAL WEDGE FIRE PIT



INSTALLATION GUIDE

BASIC FIRE FEATURES INSTALLATION NOTES FOR:

- Belvedere Fire Pit
- Dimensional Fire Pit
- Kodah Fire Pit
- Dimensional Wedge Fire Pit

Refer to product pages for specific information and details pertaining to individual products.

1. Familiarize yourself with the construction details in this Technical Guide.
2. Mark out the location for your fire pit. Note dimensions shown are nominal so mark an area slightly larger than shown.
3. Excavate for drain stone base (approx. 6 in (152 mm))
4. Fill excavated area with drain stone, level, and compact.
5. Place and center steel ring on prepared base.
6. Place blocks per the pattern. (For round kit, keep blocks 1 1/2 in (38 mm) off steel ring)
7. **WARNING!** Do not place the fire pit directly atop a patio surface. Instead, the fire pit should be incut in to the patio surface to avoid damage to the patio caused by conductive heat transfer.

ADDITIONAL STEPS ARE FOR ROUND FIRE PITS ONLY

1. After placing blocks around the ring, adjust the blocks in or out to make the circle close and fit tight. If the blocks do not close the circle, move all blocks slightly in. If the blocks seem too long, move the blocks slightly out.
2. Place caps in circle around fire pit. Adjust the caps in or out to make them fit tightly together.
3. Note: Not suitable for large fires. Fire size should not allow flame to contact caps on round fire pit.

Note: Call your local dealer for more information on gas conversion in your area.



BELVEDERE FIRE PIT

FEATURES

- Featuring the look of weathered fieldstone
- Includes 52 wetcast concrete stones and a 14-gauge steel liner

NOTE: GAS INSERT

Talk to your local producer about gas insert options in your area

Notes:

*Colors & product availability vary by region.

PALLET



Dimensions: 42 x 42 x 30 in (1067 x 1067 x 762 mm)
 Weight: ±1,320 lb (±599 kg) (inc. pallet)

INSTALLED PLAN VIEW

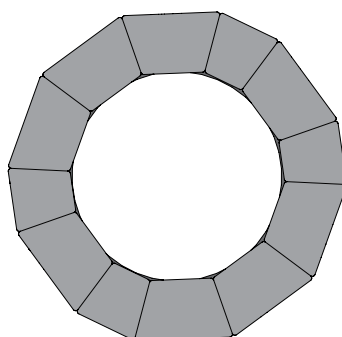

UNIT

Finished Dimensions: 58 in Dia. x 14 ½ in (1473 mm Dia. x 368 mm)

TYPICAL INSTALLATION

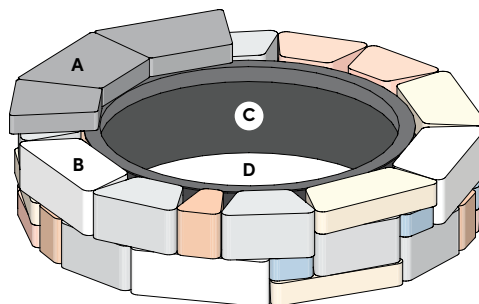

- A. Cap layer (three cap blocks shown for reference)
- B. Belvedere Fire Pit Blocks
- C. 14-gauge steel ring (37 in (940 mm) dia. opening)
- D. 6 in (152 mm) minimum drainstone base underneath

(See block pattern and cross section detail for more information)

BELVEDERE FIRE PIT

BLOCK PATTERN ELEVATION

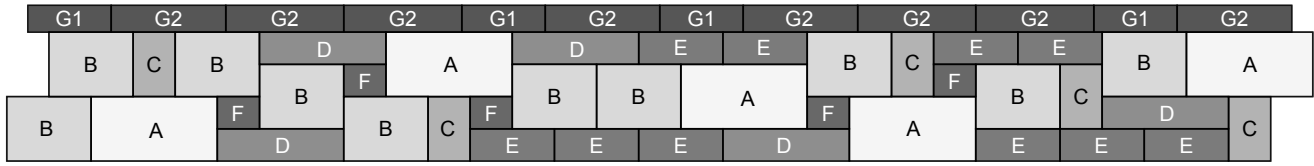

BLOCK KEY (Nominal Dimensions)



CROSS SECTION

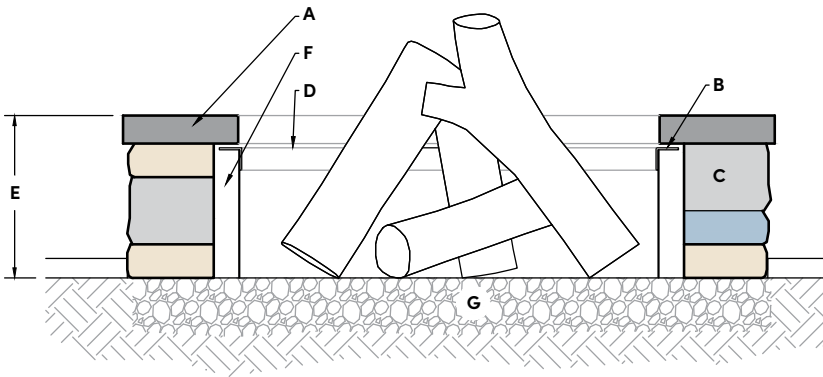

- A. Caps
- B. Caps do not contact lip of steel ring
- C. Belvedere Fire Pit blocks
- D. 14-gauge steel ring (37 in (940 mm) dia. opening)
- E. 14-1/2 in (368 mm) overall height
- F. ±2 in (±51 mm) gap
- G. 6 in (152 mm) minimum drainstone base underneath



DIMENSIONAL FIRE PIT

FEATURES

- Featuring the texture of quarried stone
- Includes 36 wetcast concrete stones and a 12-gauge steel liner

NOTE: GAS INSERT

Talk to your local producer about gas insert options in your area

Notes:

*Colors & product availability vary by region.

PALLET



Dimensions: 42 x 42 x 30 in (1067 x 1067 x 762 mm)
 Weight: ±1,130 lb (±513 kg) (inc. pallet)

INSTALLED PLAN VIEW

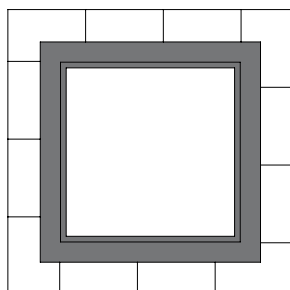

UNIT	L x W x H
Finished Dimensions:	44 x 44 x 12 in (1117 x 1117 x 305 mm)

TYPICAL INSTALLATION

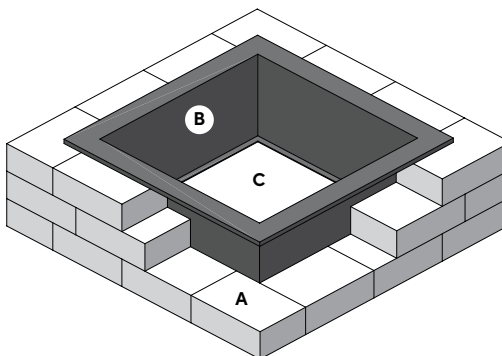

- A. Dimensional wall blocks (overlap at corners as shown)
- B. 12-gauge steel ring (28 x 28 in (711 x 711 mm) opening), 12 in (305 mm) tall, hangs directly on blocks
- C. 6 in (152 mm) minimum drainstone base underneath



KODAH FIRE PIT

FEATURES

- Featuring the modern, clean aesthetic of snapped limestone
- Includes 16 wetcast concrete stones and a 12-gauge steel liner

NOTE: GAS INSERT

Talk to your local producer about gas insert options in your area

Notes:

*Colors & product availability vary by region.

PALLET



Dimensions: 42 x 42 x 30 in (1067 x 1067 x 762 mm)
 Weight: ±1,700 lb (±771 kg) (inc. pallet)

INSTALLED PLAN VIEW

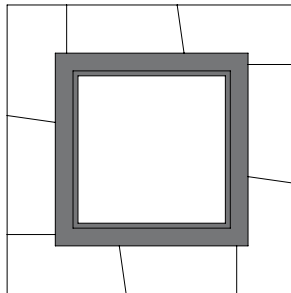

UNIT	L x W x H
Finished Dimensions:	51 x 51 x 12 in (1295 x 1295 x 305 mm)

TYPICAL INSTALLATION

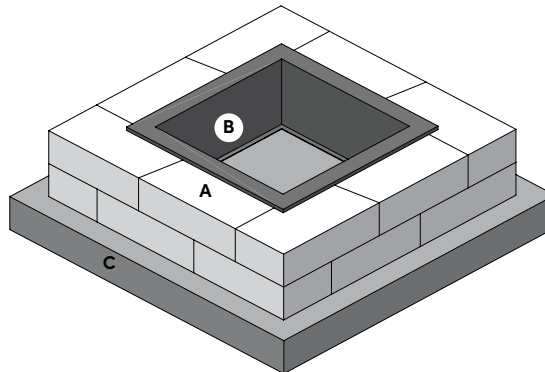

- A. Kodah wall blocks (overlap at corners as shown, and abut matching block tapers)
- B. 12-gauge steel ring (28 x 28 in (711 x 711 mm) opening), 12 in (305 mm) tall, hangs directly on blocks
- C. 6 in (152 mm) minimum drainstone base underneath



DIMENSIONAL WEDGE FIRE PIT

FEATURES

- Offering the texture of quarried stone
- Includes 48 wetcast concrete blocks, 12 cap blocks, and a 12-gauge steel liner

NOTE: GAS INSERT

Talk to your local producer about gas insert options in your area

Notes:

*Colors & product availability vary by region.

PALLET



Dimensions: 42 x 42 x 30 in (1067 x 1067 x 762 mm)
Weight: ±1,130 lb (±513 kg) (inc. pallet)

INSTALLED PLAN VIEW

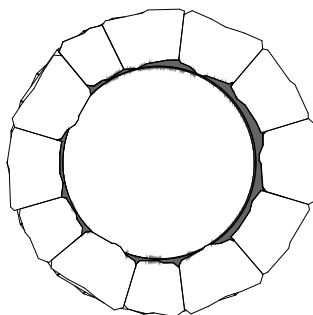

UNIT

Finished Dimensions: 58 in Dia. x 14 ½ in (1473 mm Dia. x 368 mm)

TYPICAL INSTALLATION

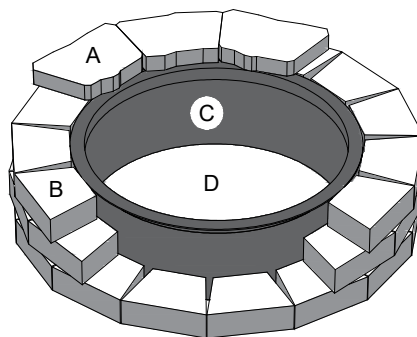

- A. Cap layer (three cap blocks shown for reference)
- B. Dimensional Wedge blocks
- C. 14-gauge steel ring (37 in (940 mm) dia. opening)
- D. 6 in (152 mm) minimum drainstone base

DIMENSIONAL WEDGE FIRE PIT

CROSS SECTION

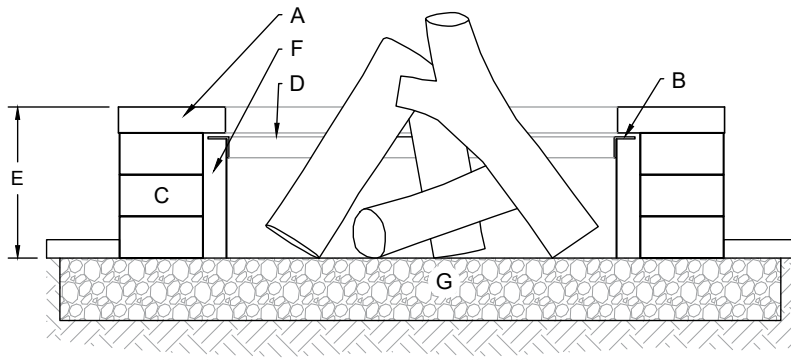

- A. Cap units
- B. Caps do not contact lip of steel ring
- C. Dimensional Wedge Blocks
- D. 14-gauge steel ring (37 in (940 mm) dia. opening)
- E. 14-1/2 in (368 mm) overall height
- F. ± 2 in (51 mm) gap
- G. 6 in (152 mm) minimum drainstone base

COPING & CAPS

DIMENSIONAL COPING
BELVEDERE COPING
BULLNOSE COPING
COLUMN CAPS





DIMENSIONAL COPING

FEATURES

- Chiseled, natural stone texture
- Comfortable dimensions for seat walls
- Formal appearance perfect for any wall application

Notes:

*Colors & product availability vary by region.

PALLET



Weight: ±2,000 lb (±907 kg) (inc. pallet)
 Linear Feet: 63 (19 m)
 Layers Per Pallet: 6
 Section: 10.5 linear ft (3.2 m) per layer



UNIT: 24 in (610 mm)

Dimensions: 24 x 12.5 x 2.5 in (610 x 318 x 64 mm)
 Weight: ±63 lb (±29 kg)
 Units Per Pallet: 18



UNIT: 18 in (457 mm)

Dimensions: 18 x 12.5 x 2.5 in (457 x 318 x 64 mm)
 Weight: ±47 lb (±21 kg)
 Units Per Pallet: 12



UNIT: COPING END

Dimensions: 19 x 12.5 x 2.5 in (483 x 318 x 64 mm)
 Weight: ±49 lb (±22 kg)
 Units Per Pallet: 6



BELVEDERE COPING

FEATURES

- Multiple face textures for each basic block size provide a more random look for your finished project
- Three standard coping blocks are finished on the front, back, and top faces with an approximate 1 in (25 mm) taper on each side from the front to the back of the block
- Two end units are finished on the front, back, top, and one of the sides with approximate 1 in (25 mm) taper on one side from the front to the back of the block
- End units are useful for constructing corners and ends

Notes:

*Colors & product availability vary by region.

PALLET



Weight: ±1,550 lb (±703 kg) (inc. pallet)
 Linear Feet: 66 (20 m)
 Layers Per Pallet: 6
 Section: 11 linear ft (3.4 m) per layer



UNIT: 9 L x W x H
 Dimensions: 6 x 10.25 x 2.25 in (152 x 260 x 57 mm)
 Weight: ±10 lb (±4.5 kg)
 Units Per Pallet: 24



UNIT: 10
 Dimensions: 12 x 10.25 x 2.25 in (305 x 260 x 57 mm)
 Weight: ±20 lb (±9.1 kg)
 Units Per Pallet: 24



UNIT: 11
 Dimensions: 18 x 10.25 x 2.25 in (457 x 260 x 57 mm)
 Weight: ±30 lb (±13.6 kg)
 Units Per Pallet: 12



UNIT: 12 (LEFT END)
 Dimensions: 18 x 10.25 x 2.25 in (457 x 260 x 57 mm)
 Weight: ±30 lb (±13.6 kg)
 Units Per Pallet: 6



UNIT: 13 (RIGHT END)
 Dimensions: 18 x 10.25 x 2.25 in (457 x 260 x 57 mm)
 Weight: ±30 lb (±13.6 kg)
 Units Per Pallet: 6



BULLNOSE COPING

FEATURES

- Rounded and smooth with a 14 in (356 mm) tread that fits perfectly into pool, step and retaining wall applications
- Thermalled texture

Notes:

*Colors & product availability vary by region.

STANDARD BULLNOSE PALLET

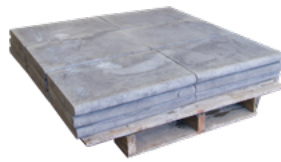

Weight: ±950 lb (±431 kg) (inc. pallet)
 Linear Feet: 33 (10 m)
 Layers Per Pallet: 3
 Section: sold by the piece

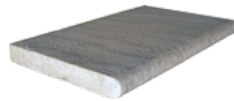

UNIT: STANDARD L x W x H
 Dimensions: 22 x 14 x 2 in (559 x 356 x 51 mm)
 Weight: ±50 lb (±23 kg)
 Units Per Pallet: 18

BULLNOSE RETURN PALLET



Weight: ±950 lb (±431 kg) (inc. pallet)
 Layers Per Pallet: 6
 Section: sold by the piece



UNIT: RIGHT L x W x H
 Dimensions: 22 x 14 x 2 in (559 x 356 x 51 mm)
 Weight: ±50 lb (±23 kg)
 Units Per Pallet: 9



UNIT: LEFT L x W x H
 Dimensions: 22 x 14 x 2 in (559 x 356 x 51 mm)
 Weight: ±50 lb (±23 kg)
 Units Per Pallet: 9



COLUMN CAPS (24, 30, 34 in) (610, 762, 864 mm)

FEATURES

- Dimensional, chiseled face
- Large format and subtle textures
- Designed to coordinate with Rosetta Hardscapes wall products

Notes:

*Colors & product availability vary by region.

24 in CAP PALLET (610 mm)

Weight: ± lb (inc. pallet)



UNIT: 24 in (610 mm)

Weight: ±120 lb (±54 kg)
Units Per Pallet: 10

30 in CAP PALLET (762 mm)

Weight: ± lb (inc. pallet)



UNIT: 30 in (762 mm)

Weight: ±230 lb (±104 kg)
Units Per Pallet: 6

34 in CAP PALLET (864 mm)

Weight: ± lb (inc. pallet)



UNIT: 34 in (864 mm)

Weight: ±295 lb (±134 kg)
Units Per Pallet: 6



COLUMN CAPS (27 in (686 mm) BELVEDERE)

FEATURES

- Irregular, weathered edge face
- Large format with Belvedere texture
- Designed to coordinate with Rosetta Hardscapes wall products

Notes:

*Colors & product availability vary by region.

27 in CAP PALLET (686 mm)

Weight: ± lb (inc. pallet)



UNIT: 27 IN

Weight:	±150 lb (±68 kg)
Units Per Pallet:	10



MAINTENANCE

With proper care, your Rosetta Hardscapes products should give you a lifetime of enjoyment.

Here are a few tips to keep your wall or patio looking its best:

STAINING:

While Rosetta Hardscapes products are available in a variety of great-looking colors, you might decide that a different shade is the right look for your backyard. Any stain suitable for typical wetcast concrete can be used. Your local dealer or producer can give you some ideas. Before applying, test the stain on an inconspicuous location, sample piece, or leftover product to make sure the color is what you had in mind. Then, follow the stain manufacturer's instructions for application.

SEALING:

Sealing the surface of your Rosetta Hardscapes product will help prevent discoloration from things like dirt, fallen leaves, spills, etc. It can also protect the unit from degradation due to freeze-thaw action and other environmental agents, like deicing salts. To seal, use a penetrating sealer that is suitable for typical wetcast concrete and follow the sealer manufacturer's instructions for application.

Note: Sealers will help protect your blocks, but won't prevent all staining.

CLEANING:

Periodic cleaning is going to help keep your hardscape products looking great throughout their years of use. Here are a few things you can do to keep your products clean:

- Avoid tracking dirt on pavers and slabs. When dirt is inevitably tracked onto your products, use a broom or leaf blower to clear the debris.

- Do not allow leaves, acorns, and other yard debris to sit on your hardscape features for long periods of time. Periodically remove the debris with a broom or leaf blower.
- If you notice stains on your hardscape products, you can gently clean with a scrub brush, clean water, and mild detergent. Avoid power washing, as this can damage the surface of the blocks.
- The type of stain may also dictate the type of cleaner you should use. For example, stubborn organic stains, like those from leaf litter and yard debris, can often be removed with an outdoor cleaner formulated specifically for organic stains.

Note: Avoid using metal brushes as it may embed small pieces into the concrete surface that can lead to future rust spots.

CHIP REPAIR:

With integral color throughout the Rosetta block, minor chips generally don't stand out. To help cover up small chips, application of a matching stain will help it blend in with the rest of the block. When applying matching stain, it is best to lightly dab onto the chipped area rather than roller application. Some chips may be where the color blend has more than one color present, so you will get the best results if the two colors are matched. Ask your local dealer or block producer for recommendations.

OTHER CARE TIPS:

As with any concrete product, deicing salts and aggressive chemicals (especially acids) can degrade Rosetta products so it is best to avoid application of deicing salts.

For additional questions please contact us at (844) 367-9763

ROSETTAHARDSCAPES.COM



ADDITIONAL INFORMATION

COLOR:

We at Rosetta Hardscapes, along with our media partners, do our best to produce print and digital materials that accurately reflect the true shades and tones of our product. However, we cannot guarantee perfect color matching for project photos, color swatches, or other picture representations. Final color selection should be made from actual material which can be viewed at your local dealer location.

Integral pigments are incorporated into the raw materials for all Rosetta Hardscapes products to intentionally produce subtle shades and color variations throughout each block or paver. Therefore no product seen in a photograph will be precisely duplicated. For the most natural appearance, install products from multiple pallets simultaneously. This will create a blended, natural look.

EFFLORESCENCE:

Efflorescence is a naturally occurring, chalky, white residue commonly found on concrete surfaces. The presence of efflorescence in no way degrades the integrity of any product. It can usually be removed with efflorescence cleaners and often washes away over time. Rosetta Hardscapes does not cover the presence of efflorescence under warranty.

PACKAGING:

Variation in color can occur where packaging comes into contact with the product. Often, these variations will fade with time. This does not affect the integrity of the material, and it is not considered to be a defect. Color variation caused by contact with packaging materials is not covered under warranty.

POLYMERIC HAZE:

Improper installation of ancillary polymeric sand products may result in the presence of polymeric haze. This discoloration can potentially mute the vibrant colors of concrete products. Hazing is not indicative of the quality of the Rosetta Hardscapes product, and should not be considered a source of concern for the product's durability. In general, polymeric haze can be cleaned and washes away over time.

HEAVY EQUIPMENT:

The broad surface dimensions of Rosetta Hardscapes's slab products are not engineered for vehicular traffic and compaction equipment. The exception to this exclusion is the more traditionally dimensioned Mission and Amaro paver collection. Both New Mission and Amaro can be used as driveway pavers and/or finish-compacted. If a compactor is used to aid in installation of New Mission or Amaro Pavers, then a urethane pad should be used with the compactor to protect the detailed surfaces of the pavers from damage.

NORMAL MAINTENANCE AND CARE:

As with any product that is continually exposed to the natural environment, cleaning and care may be desired over time to maintain the appearance of your hard scapes. Generous rinsing with water and light scrubbing with a stiff, plastic bristle brush is generally the best way to remove dirt that has accumulated over time. Cleaners and mild detergent designed to be used on concrete products may be used as well. Always follow all manufacturer instructions and test on a small area when using any cleaner. Power washers may cause damage at close range.

WINTER CARE:

All metal snow shovels and snow blower blades have the potential to damage concrete surfaces. All snowplows, snow blowers and shovels used to clear Rosetta Hardscapes products of snow should use plastic blades or guards. De-icing salts will damage concrete and should not be used with Rosetta Hardscapes products. Rosetta Hardscapes does not cover damage done by snow removal, de-icing, or improper loading under warranty.

A landscape photograph showing a stone retaining wall and a set of stone steps leading up a hillside. The area is landscaped with dark mulch, small green shrubs, and a flowering bush with pink roses. The background is filled with tall trees and dense foliage. The word "ROSETTA" is overlaid in a stylized, black, serif font with a registered trademark symbol. The 'R' is large and has a decorative underline that extends across the width of the text.

ROSETTA®



ROSETTA®

ROSETTAHARDSCAPES.COM

